





optoCONTROL CLS-K-6



	Response time $\leq 120\mu\text{s}$
	Switching frequency $\leq 4\text{kHz}$
	Analog display
	Analog output 0 - 10VDC; 0 - 20mA; 4 - 20mA

Features:

- Scanning distance up to 180mm*
- Range up to 2m*
* depending on the fiber bundle diameter
- Supply 12-30VDC
- NPN switching output
- Stable long-term behavior by monitoring and regulating the emission of the transmitter diode

Applications:

- Test & measurement tasks
- Checking length and diameter
- Production monitoring via analog output and display
- Assembly control
- Indirect displacement measurement via optical fiber with cross-section converter

Advantages:

- Low drift by transmission monitoring
- Fast response time
- Sensor monitoring via analog signal

Scaling of analog output

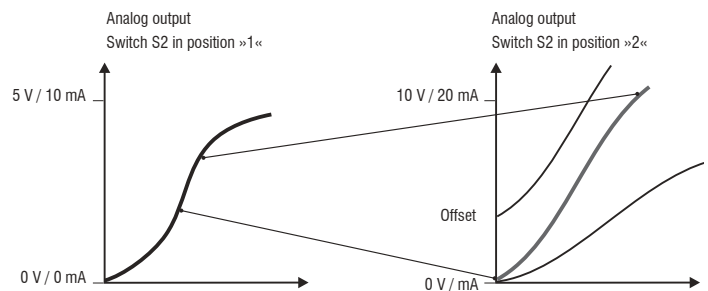

The CLS-K-61/63 amplifier offers the possibility to scale the important signal range over the entire analog range. This enables to increase the sensitivity in a certain range, e.g. for the detection of small objects.

Type CLS-K	60	61	63	65
Order No.	10030032	10030033	10040035	10040036
Supply			12-30VDC	
Residual ripple			≤ 10%	
Current consumption			~ 70mA	
Switching delay			≤ 500ms	
Switching frequency			≤ 4kHz	
Response time			≤ 120μs	
Temperature drift			≤ (-)0.5% /K	
Reproducibility			≤ 1% with Δt = 2K	
Hysteresis			4% of the measuring range value	
Analog Output	0-20mA	0-10VDC	0-20mA	4-20mA
Voltage output			load ≤ 600Ω	
Switching output			transistor 2x NPN O.C.	
Switching voltage			30VDC	
Switching current			5-100mA	
Sensitivity			adjustable via 10-level potentiometer P1	
Range switching			1:100 (Short range : Long range)	
Switching state			LED-display red/green	
Operating mode			light/dark switching output	
Protection class			IP65 (with optical fiber)	
Power supply and output			transient-protection polarity and short-circuit protection	
Operating temperature			0 to 50°C	
Storage temperature			-25°C to 70°C	
Type of connection	screw connectors	2m cable	screw connectors	screw connectors
Display	no	yes	no	no
Housing material			Makrolon® 8035 / UL94V1	
Weight			approx. 215g / 135g	

Dimensions:

Dimensions in mm, not to scale

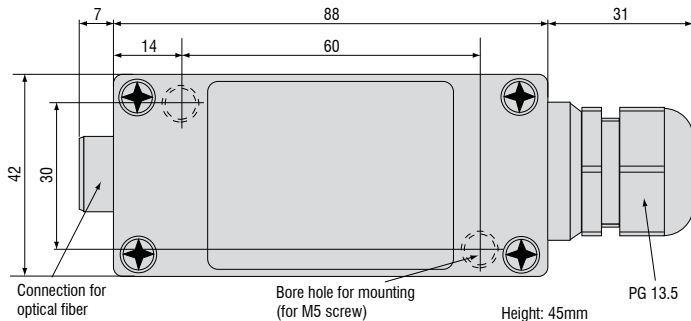

Connections:

CLS-K-60/63/65

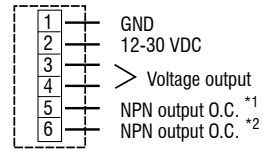

CLS-K-61

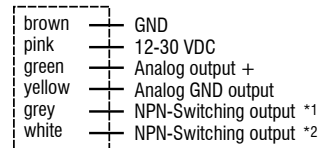

*1 dark switching
*2 light switching

Control and display interface:

Example CLS-K-61

