

■ SINGLE-PHASE POWER QUALITY ANALYSER

C.A 8230



You have just purchased a **C.A 8230 single-phase power quality analyser**, and we thank you for your confidence.

For best results with your instrument:

- **Read** this operating manual carefully,
- **Comply with** the precautions for use.



WARNING, risk of DANGER! The operator must refer to these instructions whenever this danger symbol appears.



Equipment protected by double insulation.



Earth.



The CE marking indicates conformity with European directives, in particular LVD and EMC.



The rubbish bin with a line through it indicates that, in the European Union, the product must undergo selective disposal in compliance with Directive WEEE 2002/96/EC. This equipment must not be treated as household waste.

Definition of measurement categories:

- Measurement category IV corresponds to measurements taken at the source of low-voltage installations.
Example: power feeders, counters and protection devices.
- Measurement category III corresponds to measurements on building installations.
Example: distribution panel, circuit-breakers, machines or fixed industrial devices.
- Measurement category II corresponds to measurements taken on circuits directly connected to low-voltage installations.
Example: power supply to domestic electrical appliances and portable tools.









































PRECAUTIONS FOR USE

This instrument and its accessories comply with safety standards IEC 61010-1, IEC 61010-031, and IEC 61010-2-032 for voltages of 600V in category III.

Failure to observe the safety instructions may result in electric shock, fire, explosion, and destruction of the instrument and of the installations.

- The operator and/or the responsible authority must carefully read and clearly understand the various precautions to be taken in use. Sound knowledge and a keen awareness of electrical hazards are essential when using this instrument.
- If you use this instrument other than as specified, the protection it provides may be compromised, thereby endangering you.
- Do not use the instrument on networks of which the voltage or category exceeds those mentioned.
- Do not use the instrument if it seems to be damaged, incomplete, or poorly closed.
- Before each use, check the condition of the insulation on the leads, housing, and accessories. Any item of which the insulation is deteriorated (even partially) must be set aside for repair or scrapping.
- Use only the leads and accessories supplied. Using leads (or accessories) of a lower voltage or category reduces the voltage or category of the combined instrument + leads (or accessories) to that of the leads (or accessories).
- Use personal protection equipment systematically.
- When handling the leads, test probes, and crocodile clips, keep your fingers behind the physical guard.
- All troubleshooting and metrological checks must be performed by competent and accredited personnel.

CONTENTS

1. Introduction	5	6.3  Energies generated.....	20
2. PACKING.....	5	7.  key (Harmonics).....	21
3. Presentation.....	6	7.1 Sub-menus available	21
3.1 Overall view	6	7.2  Voltage	21
3.2 On-off key	6	7.3  Current	22
3.3 Mode keys	6	7.4  Apparent power.....	23
3.4 Navigation keys	6	7.5  Voltage expert mode	23
3.5 Display screen	7	7.6  Current expert mode	24
3.6 Check light.....	7	8.  KEY (Screen grab)	25
3.7 Optical interface.....	7	8.1 Screen grab	25
3.8 Terminals.....	7	8.2 Management of screen grabs	25
3.9 Power supply	7	9.  KEY (Search for alarms).....	27
3.10 Prop.....	8	9.1 Sub-menus available	27
3.11 Summary of functions	8	9.2  Programming of a campaign of alarms.....	27
3.12 Abbreviations.....	9	9.3  Display of the alarms log	28
4. Key  (Configuration)	10	9.4  Erasure of the alarms log	28
4.1 Sub-menus available	10	10.  KEY (Record).....	29
4.2 Display language	10	10.1 Sub-menus available	29
4.3  Date / Time	10	10.2  Parameterising and starting of a recording campaign	29
4.4  Contrast / brightness.....	11	10.3  Voluntary stoppage of the recording campaign.....	30
4.5  Colours	11	10.4 Automatic stopping of the recording campaign	30
4.6  Calculation parameters.....	11	10.5  Viewing a recording	30
4.7  Connection.....	11	10.6 Examples of recordings	31
4.8  Current sensor	12	10.7  Erasure of a recording campaign	33
4.9  Recording	12	10.8  <i>Inrush</i> mode (starting current)	33
4.10  Alarm	13	10.9  Voluntary stoppage of recording <i>Inrush</i> ..	34
4.11  Erasure of data	14	10.10 Viewing the recording <i>Inrush</i>	34
4.12  Information	14	11. Use.....	36
5.  KEY (Waveforms).....	15	11.1 Starting	36
5.1 Sub-menus available	15	11.2 Configuring the C.A 8230	36
5.2  Waveforms.....	15	11.3 Placing the cords	37
5.3  Max - Min	16	11.4 Measurement of waveforms 	37
5.4  Simultaneous display	16	11.5 Detection of alarms 	37
5.5  Phase rotation	17	11.6 Recording 	38
6.  KEY (Powers and energies).....	19	11.7 Measurement of energies 	38
6.1 Sub-menus available	19		
6.2  Energies consumed	19		

11.8 Measurement of harmonics 	38
11.9 Transferring data to a PC	38
11.10 Erasure of the data	38
11.11 Stopping	38
11.12 Power supply of the C.A 8230	38
12. Maintenance	39
12.1 Important recommendation	39
12.2 Recharging the battery	39
12.3 Cleaning the housing	39
12.4 Metrological check	39
12.5 Repair	39
12.6 Upgrading the embedded software	39
12.7 Sensors	39
13. gEnEral CHARACTERISTICS	40
13.1 Housing	40
13.2 Power supplies	40
13.3 Conformity	40
13.4 Environmental conditions	41
14. Functional characteristics	42
14.1 Reference conditions	42
14.2 Electrical characteristics	42
15. APPENDICES	46
15.1 Mathematical formulas	46
15.2 Hysteresis	47
15.3 Minimum scale values displayed in the <i>Waveforms</i> mode	48
15.4 4-quadrants diagram	48
16. TO ORDER	49
16.1 Power Quality Analyser C.A 8230	49
16.2 Accessories	49
16.3 Spares	49

1. INTRODUCTION

The C.A 8230 is a category III (IEC 61010-1) 600V single-phase AC+DC power quality analyser with graphic display. It measures the RMS values, powers, and disturbances of electricity distribution networks and can be used for a snapshot of the main characteristics of a network and to track variations of the different parameters over time.

It is compact and impact-resistant, and its ergonomics and simple interface make using it pleasant and intuitive.

The C.A 8230 can be used not only for a snapshot of the main characteristics of a network, but also to track their variations over time. The multitasking measurement system simultaneously performs all functions required for the measurement of the various quantities, detection, continuous recording, and display without constraint. And it provides great flexibility in the choice of sensors, for measurements from a few hundred milliamperes (MN93A) to several kiloamperes (Amp**FLEX**).

The C.A 8230 is intended for the technicians and engineers of inspection and maintenance teams of industrial companies and government agencies at the yellow rate (36 to 250kVA) and green rate (> 250kW), for checking and diagnostic measurements on single- or three-phase low-voltage networks.

The main measurements performed are:

- Measurement of RMS AC voltage up to 600 V (phase-neutral) and 660 V (phase-phase) - provided that 600 V between phase and earth is not exceeded.
- Measurement of RMS AC current up to 6,500 A RMS.

- Measurement of network frequency from 40 Hz to 69 Hz.
- Calculation of the peak factor for the current and the voltage.
- Calculation of the K factor for the current (transformers).
- Calculation of the short-term *Flicker* for the voltage.
- Measurement of the angles of harmonics, up to order 50, and of their levels (with respect to the fundamental) in voltage, current, or power. Calculation of the global level of harmonic distortion.
- Measurement of active, reactive, and apparent power, by phase and total.
- Calculation of the power factor, displacement factor, and tangent.
- Totalling of the energy generated and consumed starting from a time chosen by the operator.
- Tracking of the mean value of any parameter whatever, calculated over a period of from 1 second to 15 minutes. Storage of the values for a duration limited only by the memory of the instrument.
- Recording, timestamping, and characterisation of disturbances: voltage overloads, brown- and blackouts, overshooting of powers, harmonic thresholds, etc.

2. PACKING

Item	Qty
Set of 2 banana jack-banana jack safety cables (red / black).	1
Set of 2 alligator clips (red / black).	1
Set of 2 contact tips (red / black).	1
One MN93A clip ('black') or one Amp FLEX A193 450 mm ('black') sensor or without a current sensor.	-
Rechargeable NiMH storage battery in AA format (LR6 - NEDA 15), capacity at least 1800mAh.	6
Mains power unit (600V, cat. III).	1
Optical USB cable.	1

Carrying bag.	1
<i>DataViewer</i> data processing software on CD-ROM.	1
Operating manual and various other documents on CD-ROM.	1

Optional equipment

Item
5A adapter (three-phase).
MN93, MN93A, C193, E3N and PAC93 clips and Amp FLEX A193 sensor, 800mm and 450mm.

3. PRESENTATION

3.1 Overall view

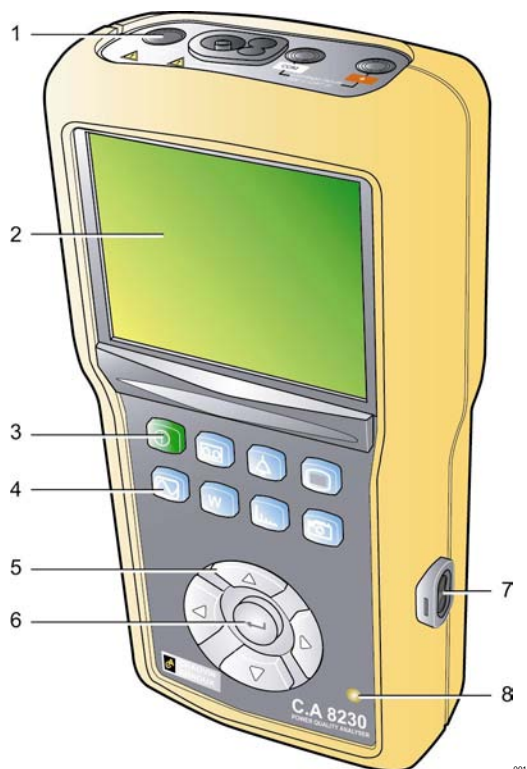



Figure 1: Overall view of the C.A 8230.









Item	Function	See §
1.	Terminals.	3.8
2.	Display screen.	3.5
3.	On-Off key (green).	3.2
4.	Mode keys (blue).	3.3
5.	Navigation keys.	3.4
6.	Validation key.	3.4
7.	RS232 infrared optical interface.	3.7
8.	Check light.	3.9.3

3.2 On-off key

Pressing the  key switches the instrument on; it is operational after approximately 5 seconds. Pressing again switches the instrument off; the records (measurements and screen grabs) and parameterising are kept. However, confirmation of switching off is requested if a recording campaign is in progress.





3.3 Mode keys

These give access to the specific modes:

Item	Mode	Page
	Display of a stored record, parameterising of a new recording campaign, erasure of a recording campaign, recording in <i>Inrush</i> mode. The configurations are defined using the Record menu of the  mode.	29
	Display of recorded alarms, search for alarms in a period that can be parameterised, erasure of alarms. The alarm triggering and stopping thresholds are defined using the Alarm menu of the  mode.	27
	Parameterising of the instrument (date, time, contrast, brightness, type of connection, alarms, recording configurations, etc.).	10
	Display of the voltage and current waveforms, display of minimum and maximum values, of summary tables, determination of phase rotation.	15
	Display of measurements linked to powers and energies.	19
	Display of curves linked to harmonics:	21
	Screen grab for later viewing (press for more than 2 seconds) or management of screen grabs.	25

3.4 Navigation keys

A set of 4 direction keys and one validation key allows navigation in the menus.

Item	Function
	Move up one line in a menu or list of choices.
	Move down one line in a menu or list of choices.
	Move one character or field to the right in a menu, move the graphic cursor, make a selection, or adjust a cursor.
	Move one character or field to the left in a menu, move the graphic cursor, make a selection, or adjust a cursor.
	Confirms (validates) the item selected, enters or exits from the edit mode.

3.5 Display screen

This colour liquid-crystal display unit (320x240 pixels) is used to view the measurements and the parameterising menus. When the C.A 8230 is switched on, the *Waveforms* screen is automatically displayed. Information about this screen is given in chapter 5, on page 15.

Generally speaking, the following information is displayed:

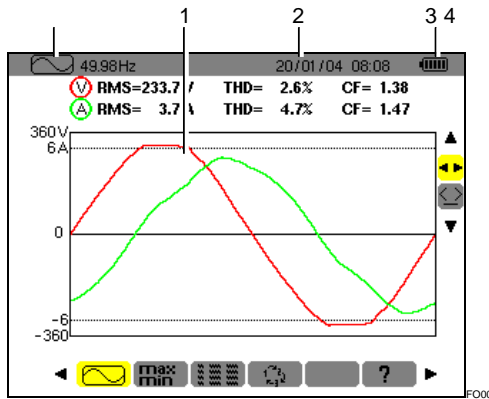

Figure 2: Example of a display screen.

Item	Function
1.	Reminder of the mode activated by the key (§ 3.3).
2.	Screen of the active mode.
3.	Current date and time.
4.	Battery charge level.

Automatic standby switching is activated after five minutes of non-use of the keys during an alarm campaign or a recording campaign (pending or in progress). Pressing any key re-activates the instrument.

3.6 Check light

This light (Figure 1, item 8) (yellow LED), located at the bottom right of the instrument, is lit:

- **Steadily** when the instrument is supplied by the external power supply.
- **Flashing** when the C.A 8230 is switched to standby and is not operating on mains power.

3.7 Optical interface

This provides an optical, and therefore isolated, two-way connection (Figure 1, item 7) between the C.A 8230 and a PC for transmission of the information in memory (alarms, screen grabs, motor starts, records) and all instantaneous measurements and waveforms displayed on the screen of the C.A 8230.

The PC to C.A 8230 direction is used to transfer any upgrades of the embedded software and certain configurations.

The transfer rate is determined automatically by the C.A 8230 according to the software used; the maximum rate is 115.2 kbps.

3.8 Terminals

Located on the top, these have the following functions:

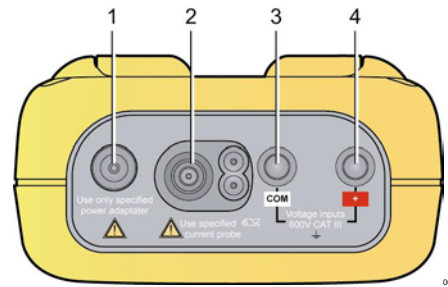





Figure 3: Terminals on the top.

Item	Function
1.	External power supply by specialised mains power unit.
2.	Four-point input for ammeter sensor (MN clip, C clip, AmpFLEX, etc.).
3.	Safety socket of the voltage measurement cable (negative terminal).
4.	Safety socket of the voltage measurement cable (positive terminal).

3.9 Power supply

3.9.1 Indication of charge level

Once in service, the battery icon at top right on the screen indicates the charge condition of the storage batteries. The number of bars inside the icon is proportional to the charge level.

Icon	Charge condition
	Battery fully charged.
	Battery discharged.
	Moving bars: battery charging.
	No battery, C.A 8230 supplied by mains power unit.

When the capacity of the battery is too low, the message 'Battery too low. The instrument will be switched off soon' is displayed in the centre of the screen. The instrument is switched off 1 minute after this message appears.

3.9.2 Time between charges

This is at least 8 hours with back-lighting on and at least 40 hours with the screen-saver activated (display unit off) when the storage batteries supplied with the instrument are used.

3.9.3 Recharging of the storage batteries

See also § 12.2, on page 39. The storage batteries are recharged using the mains power unit supplied with the instrument. It is connected to the C.A 8230 using the jack (Figure 3, item 1). Use only the mains power unit supplied with the equipment.

With fully discharged storage batteries, the charging time is approximately four hours. Once the battery is recharged, the instrument uses mains power and does not discharge the battery.

Note: when the mains power unit is connected, the orange indicator (Figure 1, item 8) lights.

3.9.4 Changing the storage batteries

When you change the storage batteries, you must disconnect the C.A 8230 from mains and from the network being measured; the instrument is then no longer supplied by any voltage source. The C.A 8230 preserves the timestamp settings for approximately 1 minute.

3.9.5 Storage batteries

The C.A 8230 is powered by six rechargeable NiMH storage batteries (Figure 4, item 1) in AA format (LR6 - NEDA 15) having a capacity of at least 1800 mAh. At least 8 hours of self-contained operation with the screen on is ensured. If the screen is off (standby mode during an alarm or recording campaign), at least 40 hours of self-contained operation are ensured.

The storage batteries can be reached, from the back of the C.A 8230, after turning the "quarter turn" lock (Figure 4, item 2) anti-clockwise; use a coin (Figure 4, item 3).

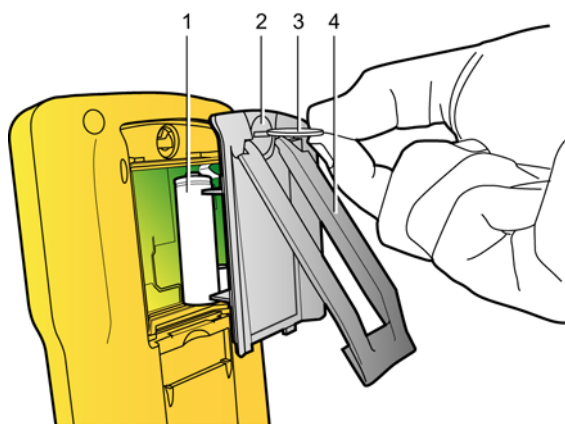

Figure 4: Access to storage batteries. 003

3.9.6 Operation on mains power

The presence of the storage batteries is not essential for operation on mains power. However, there is a risk of losing data if the mains power is disconnected during recording, for example.

3.10 Prop

A retractable prop (Figure 4, item 4) on the back of the C.A 8230 holds the instrument in position 30° from the horizontal.

3.11 Summary of functions

3.11.1 Measurement functions

- RMS AC voltage up to 600 V.
- RMS AC current up to 6,500 A.
- DC voltage and current.
- RMS values on half-period, minimum and maximum in voltage and current.
- Peak values of voltage and current.
- Frequency of 50Hz and 60Hz networks (measurement range: 40Hz to 70Hz).
- Peak factor of current and voltage.
- K factor (KF) of current (for transformers).
- Distortion factor (DF) of current and voltage (also called THD-R).
- Total harmonic distortion (THD) of current and voltage (also called THD-F).
- Active, reactive (capacitive and inductive), and apparent power.
- Power factor (PF) and displacement factor (DPF or $\cos \phi$).
- Total active, reactive (capacitive and inductive), and apparent power in balanced three-phase mode (3 Φ) with or without neutral.
- Determination of order of phase rotation (2-wire method): display of phase order of a three-phase network.
- Selection of current transformer ratio for the MN93A (5A rating) clip and the 5A adapter.
- Selection of current transduction ratio for the E3N clip.
- Automatic recognition of type of current sensor.
- Display of waveforms (voltage and current).
- Short-term flicker (PST).
- Active, reactive (capacitive and inductive), and apparent energy (total in balanced three-phase mode).
- Harmonics of current and voltage up to order 50: RMS value, percentage with respect to the fundamental, minimum and maximum and (in single-phase mode only) sequence of the harmonics.
- Harmonics of the apparent power (in single-phase mode only) up to order 50: value, percentage with respect to the fundamental, minimum and maximum.

3.11.2 Display functions

- Bar charts of harmonics.
- "Inrush" recording (starting current): display of parameters useful for studying the starting of a motor.
 - Instantaneous value of the current at the time indicated by the cursor.
 - Maximum instantaneous value of the current (for the whole start).
 - RMS value of the half-period (or lobe) of the current on which the cursor is placed.
 - RMS value, maximum half-period, of the current (for the whole start).
 - Starting time of the motor start.
- Screen grabs.
- Recording campaign ("data logging") (960kB of memory with timestamping and programming of the beginning and end of a recording campaign). Representation, in the form of bar charts or curves, of the mean values of many parameters versus time.
- Alarms. Listing of recorded alarms (log of up to 4096 alarms) (64kB) versus the thresholds programmed in the configuration menu. Programming of the beginning and end of an alarm surveillance campaign.

3.11.3 Configuration functions

- Configuration of the date and time.
- Configuration of the brightness and contrast of the screen.
- Configuration of the colours of curves.
- Configuration of the power and reactive energy calculation (with or without harmonics)
- Choice of language.
- Choice of connection (standard single-phase or balanced three-phase).
- Configuration of recordings and of alarms.
- Erasure of all data.

3.12 Abbreviations

The display unit of the C.A. 8320 uses abbreviations of electrical symbols. These symbols, also used in this manual, are the following:

Unit	Designation
\cong	AC and DC components.
\sim	AC component only.
=	DC component only.
ϕ	Phase shift of phase-to-earth voltage with respect to phase-to-earth current.
Acf	Peak factor of the current.
Ahx	Level of order 'x' harmonic in current.
Akf	K factor (for transformers).
Arms	True RMS current.
Athd	Total harmonic distortion of the current.

CF	See Vcf and Acf.
DC	DC component of the current and of the voltage (phase-to-phase in balanced 3 ϕ mode).
DF	Distortion factor (of the voltage or of the current).
DPF	Displacement factor (cosine of ϕ).
Hz	Frequency of the network studied.
KF	See Akf.
PF	Power factor (ratio of active power to apparent power).
PST	See VPST.
RMS	See Arms and Vrms.
Tan	Tangente of angle ϕ .
THD	See Athd and Vthd.
VA	Apparent power (total if 3 ϕ).
VAh	Apparent energy (consumed or generated; total if 3 ϕ).
VAR	Reactive power (total if 3 ϕ).
VARh	Reactive energy (consumed or generated; total if 3 ϕ).
Vcf	Peak factor of the voltage (phase-to-phase if 3 ϕ).
Vhx	Level of order 'x' harmonic in voltage (phase-to-phase 3 ϕ).
VPST	Short-term flicker.
Vrms	True RMS voltage (phase-to-phase 3 ϕ).
Vthd	Total harmonic distortion of the voltage (phase-to-phase 3 ϕ).
W	Active power (total 3 ϕ).
Wh	Active energy (consumed or generated; total 3 ϕ).



4. KEY (Configuration)

This key is used to configure the C.A 8230: the instrument must be parameterised before it is first used, and subsequently as necessary; the configuration remains in memory even when the instrument is off.

4.1 Sub-menus available

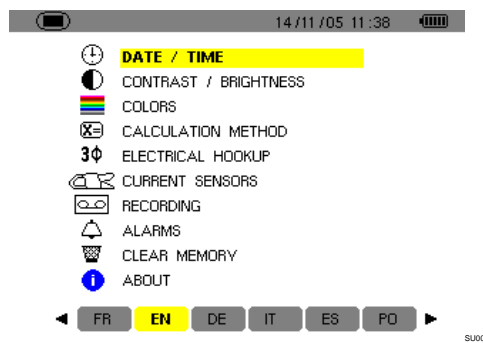
Select the sub-menu with ▲▼ and validate by pressing ↵.



Literal	Sub-menu	See §
Date/Time	Set the system date and time.	4.3
Contrast Brightness	Adjustment of the contrast and brightness of the display unit.	4.4
Colours	Definition of the colours of the voltage and current curves.	4.5
Parameters	Choice of using or not using harmonics in calculations of reactive quantities (power, energy).	4.6
Connection	Choice of the type of connection to the network (attention: some calculations depend on the connection).	4.7
Sensor	Parameterising of the sensor: MN93A with 5A rating, E3N or 5A adapter.	4.8
Recording	Choice of the parameters to be recorded for  .	4.9
Alarm	Definition of the alarms used by  .	4.10
Erase	Re-initialisation of the C.A 8230 (factory configuration).	4.11
Information	Software and hardware versions and serial number of the instrument.	4.12

4.2 Display language

The display language is chosen from among the six languages available (French, English, German, Italian, Spanish, and Portuguese). The active language is displayed by the icon on a yellow ground at the bottom of the display.

- Select the display language using the ◀▶key; the text of the menu is immediately updated.

Note: all texts displayed depend on this parameter.

4.3 Date / Time

Defines the system date and time. The display looks like this:

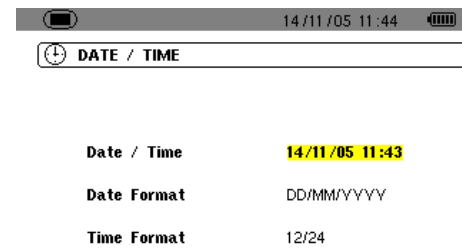



Figure 5: The Date/Time menu.

1. The Date/Time field is highlighted in yellow. To change the date/time, press ↵; the yellow highlighting disappears. Press ▲▼ to change a value and press ◀▶ to go from one field to another. Validate by ↵. The yellow highlighting is displayed.
2. To change the format of the date, move the yellow highlighting to the field using ▲ or ▼. Press ↵; the yellow highlighting disappears. Press ▲▼ to select the DD/MM/YYY mode or MM/DD/YYY. Validate by ↵. The yellow highlighting is displayed.
3. To change the format of the time, position the yellow highlighting on the field using ▲▼. Press ↵; the yellow highlighting disappears. Press ▲▼ to select the 12/24 or AM/PM mode. Validate by ↵. The yellow highlighting is displayed.
 - 12/24: display of time in 24-hour format.
 - AM/PM: display of time in 12-hour format. The time is followed by "AM" or "PM".
4. Return to the **Configuration** menu by  or display another menu by pressing a blue key.

4.4 Contrast / brightness

Defines the contrast and brightness of the display unit; the display looks like this:

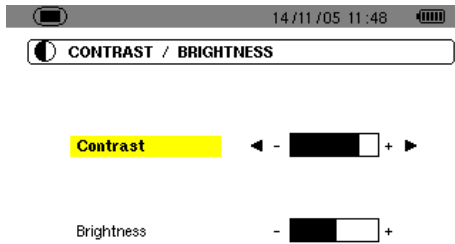

Figure 6: The Contrast/brightness menu.

1. Change the contrast using ◀▶.
2. Go to the next field using ▲▼. Change the brightness using ▶◀.
3. Return to the **Configuration** menu by pressing the ↵ or key.

4.5 Colours

Defines the colours of the voltage and current curves of the screens accessible by the , , and keys. The colours available are: Magenta, Red, Dark red, Dark brown, Brown, Orange, Yellow, Green, Dark green, Blue, Dark blue, Light grey, Grey, Dark grey, Black. The display looks like this:

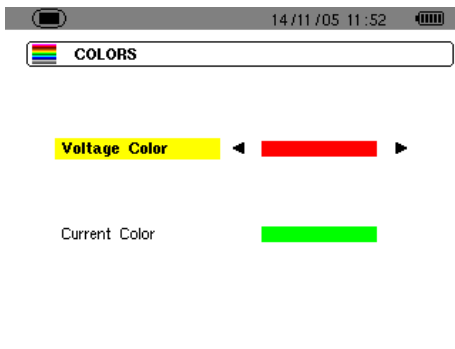

Figure 7: The Colours menu.

1. Select the colour of the voltage curves using ▶◀.
2. Go to the next field using ▲▼. Select the colour of the current curves using ▶◀.
3. Return to the **Configuration** menu by pressing the ↵ or key.

4.6 Calculation parameters

Determines whether or not the harmonics are used in calculating reactive quantities (power and energy).

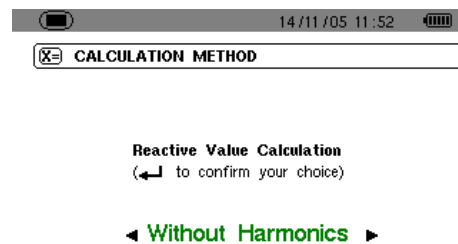

Figure 8: The Calculation parameters menu.

1. Select **With harmonics** or **Without harmonics** using ▶◀.
 - **With harmonics**: the harmonics are included in the calculation of the reactive quantities.
 - **Without harmonics**: only the fundamental is used in the calculation of the reactive quantities.
2. Validate using ↵ (this validation is mandatory for application of the parameter). The return to the **Configuration** menu is immediate.

4.7 3Φ Connection

Defines the type of connection of the C.A 8230 to the network.

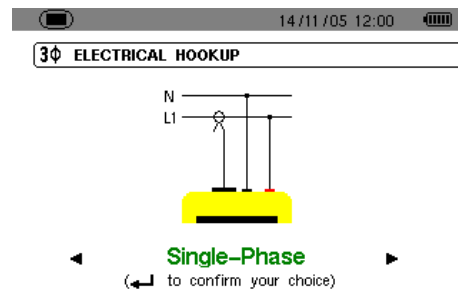

Figure 9: The Connection menu.

1. Select **single-phase** or **balanced three-phase** using ▶◀.
 - **Single-phase**: measurement of the phase-to-earth voltage associated with the phase-to-earth current of a phase.
 - **Balanced three-phase**: measurement of the complementary phase-to-phase voltage of the phase of which the phase-to-earth current is measured. This connection is used to calculate:
 - . The total powers and energies of a balanced three-phase network (W, Wh, VAR, VARh, VA, and VAh).

- . The quantities common to the three phases (phase shift of the phase-to-earth voltage with respect to the phase-to-earth current, PF, DPF, and tangent).

2. Validate using \leftarrow (this validation is mandatory for application of the parameter). The return to the **Configuration** menu is immediate.

4.8 Current sensor

Automatically displays the type of current sensor connected to the current sensing probe input (Figure 37).

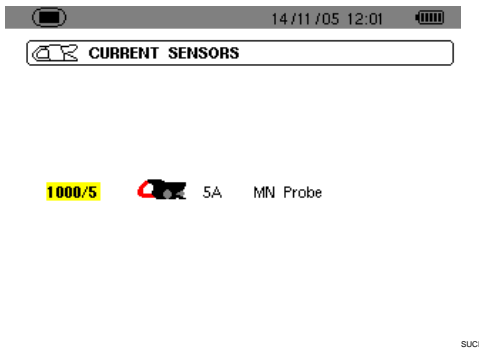

Figure 10: The Current sensor menu.

The possibilities are:

- MN93 clip: 200 A.
- MN93A clip: 100A or 5 A.
- C193 clip: 1000 A.
- AmpFLEX A193: 3000 A.
- PAC93 clip: 1000 A.
- E3N clip : 100 A (sensitivity 10 mV/A) or 10 A (sensitivity 100 mV/A).
- 5A three-phase adapter.

Attention: if a 5A MN93A clip or a E3N clip or an Adapter is used, the parameterising is as follows:

1. Definition of the transformation ratio or transduction ratio.

- For a 5A clip, press \leftarrow to parameterise the primary current (1 A to 2,999 A) / secondary current (1 A or 5 A) transformation ratio. Use \leftarrow to select the fields and \blacktriangle to select the values. Proceed in the same way for the primary current and the secondary current.
- For a E3N clip, press \leftarrow to parameterise the transduction ratio. Use \blacktriangle to select the values (sensitivity 10 mV/A or 100 mV/A).
- Adapter: press \leftarrow to parameterise the current primary (1 A to 2,999 A) / current secondary (1 A or 5 A) transformation ratio. Use \leftarrow to select the fields and \blacktriangle to select the values. Proceed in the same way for the primary current and the secondary current.

2. Validate with \leftarrow (this validation is mandatory for application of the parameter).

3. Return to the **Configuration** menu by pressing the  key.

4.9 Recording

The C.A 8230 has a recording function -  key - (chapter 10, page 29) for digital recording of measured and calculated values (Hz, Vrms, Vthd, Athd, etc.). Since not all values are necessarily of interest for a given recording campaign, those it is more particularly desired to supervise are selected in this recording parameterising menu. Four independent configurations can be parameterised in this way, each corresponding to a specific need of the user, who when the time comes can simply select the desired configuration in the list of four configurations parameterised here.

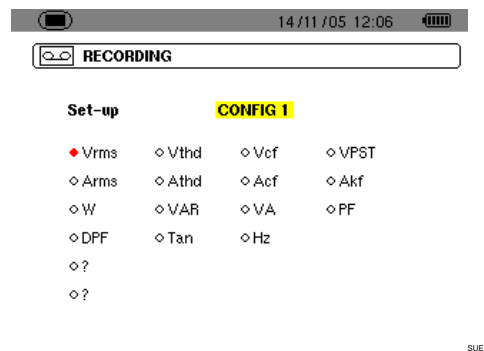

Figure 11: In this example, only measurements concerning Vrms will be recorded.

1. The CONFIG1 zone is highlighted in yellow.
2. To define CONFIG1, go directly to point 3. To define configurations CONFIG2, CONFIG3 or CONFIG4, press \leftarrow and use the \blacktriangle key to select the desired configuration number. Press \leftarrow again to validate.
3. Use the \blacktriangle and \blacktriangledown keys to select each item of information to be recorded in the configuration currently being defined by pressing \leftarrow (the selection is then marked with a red spot).

The values that can be recorded are:

Unit	Designation
Vrms	RMS voltage (phase-to-phase 3 ϕ).
Vthd	Total harmonic distortion of the voltage (phase-to-phase 3 ϕ).
Vcf	Peak factor of the voltage (phase-to-phase 3 ϕ).
VPST	Short-term flicker.
Arms	RMS current.
Athd	Total harmonic distortion of the current.
Acf	Peak factor of the current.

Table continued on page 13.

Table continued from page 12.

Akf	K factor (for transformers).
W	Active power (total 3 ϕ).
VAR	Reactive power (total 3 ϕ).
VA	Apparent power (total if 3 ϕ).
PF	Power factor.
DPF	Displacement factor.
Tan	Tangent.
Hz	Network frequency.
?	See remark below.

Specific character of last two lines

These are recalled below:



Figure 12: These two lines concern the harmonics.

These two lines concern recording of the harmonics of the quantities VAh, Vh, and Ah (VAh is meaningful only for a single-phase connection). For each of these quantities, it is then possible to select the orders of harmonics to be recorded (between 0 and 50) and, possibly, in this range, odd harmonics only. Proceed as follows:

- **Select the value to be recorded:** with the $\circ ?$ line highlighted in yellow, press the \leftarrow key. Select the value (VAh, Ah, Vh) for which the harmonics will be recorded. Validate using \rightarrow ; the field is highlighted in yellow. Press \rightarrow .
- **Select the order of the starting harmonic:** when the first is highlighted in yellow, press the \leftarrow key. Select the order starting from which the harmonics will be recorded. Validate using \rightarrow ; the field is highlighted in yellow. Press \rightarrow .
- **Select the last harmonic:** with the second (greater than or equal to the order of the starting harmonic) is highlighted in yellow, press the \leftarrow key. Select the highest-order harmonic to be recorded. Validate using \rightarrow . The field is highlighted in yellow. Press \rightarrow .
- **Odd harmonics** (selected and unselected by pressing \leftarrow):
 - *Selected*, only odd harmonics between the two orders defined above will be recorded.
 - *Not selected*, all harmonics (even and odd) between the two orders defined above will be recorded.

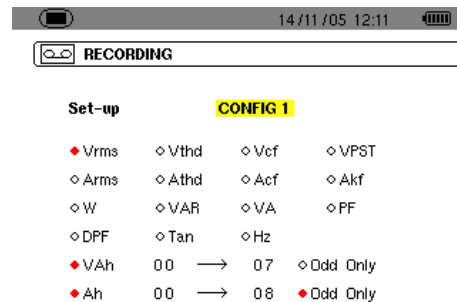

SUE0

Figure 13: In this example (bottom line), harmonics 0 to 7 will be recorded for the VAh measurement. For the Ah measurement, only odd harmonics between 0 and 8 (in other words 1, 3, 5, and 7) will be recorded.

To unselect a value selected by error, go to the value using the $\uparrow \downarrow$ or $\leftarrow \rightarrow$ keys and press \leftarrow again.

4. Exit from this sub-menu by pressing \square .

Note: the characteristics of each of the configurations can also be viewed using the \square key. See chapter 10, on page 29.

4.10 Alarm

This screen defines the alarms that will be used by the Search for alarms \square function (see chapter 9, on page 27).

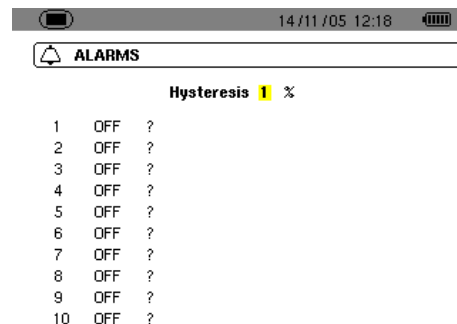

SUAL

Figure 14: The Alarm menu.

1. When the hysteresis has been selected, press \leftarrow to enter the edit mode. Change this value (1, 2, 5, or 10%) using the $\uparrow \downarrow$ or $\leftarrow \rightarrow$ key.

The hysteresis is the percentage added to or subtracted from the selected alarm threshold that stops the alarm if there is an overshoot (for details, see § 15.2, on page 47). The hysteresis is the same for all active alarms.

2. Press \leftarrow to validate the hysteresis value and \uparrow or \downarrow to reach the threshold of alarm no. 1.

If necessary, select another alarm using $\uparrow \downarrow$ (or $\leftarrow \rightarrow$ if the alarm is indeterminate - "?" icon).

3. Press \leftarrow to define the characteristics of the selected alarm.

4. Press $\uparrow \downarrow$ and select the target of the alarm (Vrms, Arms, VPST, etc. - see table in § 4.9,

on page 12) for which this alarm will be defined. Press \leftarrow to validate and \rightarrow to go to the next field.

5. For each of the fields of the same line, use the \leftarrow key to enter and exit from the edit mode and \leftarrow \rightarrow to change fields. In the edit mode, \blacktriangle \blacktriangledown is used to change the value in question; \blacktriangleleft \blacktriangleright is used to move from digit in digit.

For each alarm to be defined, select:

- The target of the alarm (Vrms, Arms, VPST, Vcf, Acf, Hz, Akf, Vthd, Athd, W, VAR, VA, DPF, PF, Tan, Vh, Ah, or VAh - see the table of abbreviations on page 9).
Note: VAh is meaningful only in the single-phase context.
- The order of the harmonic concerned (for Vh, Ah, and VAh only).
- The direction of the alarm ($>$ or $<$ for Hz, Vrms and Arms).
- The alarm triggering threshold (possible adjustment of the power of 10 of the unit for W, VAR, and VA).
- The minimum duration of overshoot of the threshold for validation of the alarm (in minutes, seconds, or, for Vrms and Arms only, in hundredths of a second).
- Activation (ON) or deactivation (OFF) of the alarm.

6. Return to the **Configuration** menu using .

Example 1: this alarm line is read as follows:

```
Hysteresis 1%
3 ON Arms <0010A 01s
```

The hysteresis is 1%. The alarm can be triggered (ON). During an alarm campaign () alarm no. 3 will be triggered if the RMS current (Arms) is less than 10 A (<0010A). The alarm will be stopped when the current exceeds 10.1 A (10 A + 1% hysteresis). The alarm will be recorded in the alarms log if it lasts 1 second or more (01 s).

Example 2: this alarm line is read as follows:

```
Hysteresis 1%
1 ON Vh 2 >10.0% 10s
```

The hysteresis is 1%. The alarm can be triggered (ON). During an alarm campaign () alarm no. 1 will be triggered if the voltage level of harmonic 2 (Vh 2) exceeds 10% (>10.0%). The alarm will be stopped as soon as the voltage level of harmonic 2 falls back below 9.9% (10% - 1%). The alarm will be recorded in the alarms log if it lasts 10 seconds or more (10 s).

4.11 Erasure of data

Erase all data of the user (configuration, alarms detected, screen grabs, recordings).

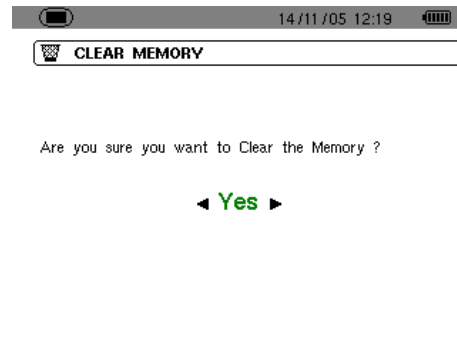

Figure 15: The Erasure of data menu.

1. Using the \leftarrow or \rightarrow key, select **Yes** to erase the data or **No** to exit.

2. Press \leftarrow . If, in the preceding point, the choice was:

- **No**, you return to the Parameterising menu.
- **Yes**, the message *Data being erased* is displayed. The instrument then switches itself off automatically. When it is next started, the menus are in English; the C.A 8230 contains no information (factory configuration).

Note: pressing the  key returns you to the Configuration menu.

4.12 Information

This screen displays the serial number of the instrument, the software version, and the hardware version.

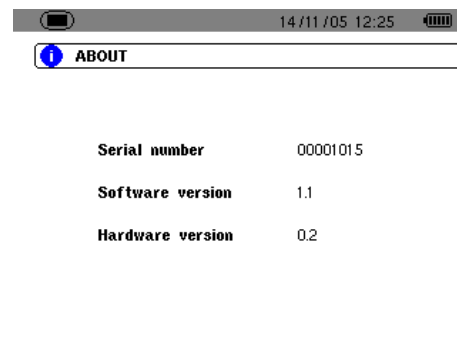



Figure 16: The Information menu.

Return to the Configuration menu by pressing \leftarrow or .

5. KEY (Waveforms)

This key is used to display the current and voltage curves and the measured values and values calculated from the voltages and currents (except power, energy, and harmonics).

5.1 Sub-menus available

These are listed in the screen shown below and described individually in the sections that follow.

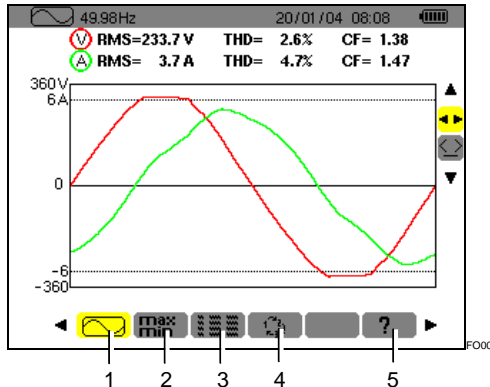

Figure 17: Example of display of Waveforms.

Item	Sub-menus	See
1.	Display of the waveforms (current, voltage) of the RMS value, of the THD, and of the peak factor with time displacement cursor.	5.2
2.	Measurement of the maximum, minimum, and mean values (RMS over half-period) of the voltage and current, and those of the positive and negative instantaneous peaks of the voltage and current.	5.3
3.	Simultaneous display of all voltage and current measurements (RMS, DC, THD, CF, PST, KF, DF).	5.4
4.	Determination of the phase order.	5.5
5.	On-line help in this mode.	

Note: in the case of a balanced three-phase connection (selection in *Configuration of Connection / Balanced three-phase*, see § 4.7, page 11), a 3 ϕ symbol is displayed in the top bar of the screen. The measurements displayed are then measurements of the phase-to-phase voltage and the phase-to-earth current.



Figure 18: The 3 ϕ sign at the top of the screen indicates a balanced three-phase connection configuration.

Note: refer to § 15.3 on page 48 for details of the display in the X mode Waveforms.

5.2 Waveforms

This function displays the waveforms (current, voltage), the RMS value, the THD, and the peak factor with time displacement cursor.

The information displayed is read as follows.

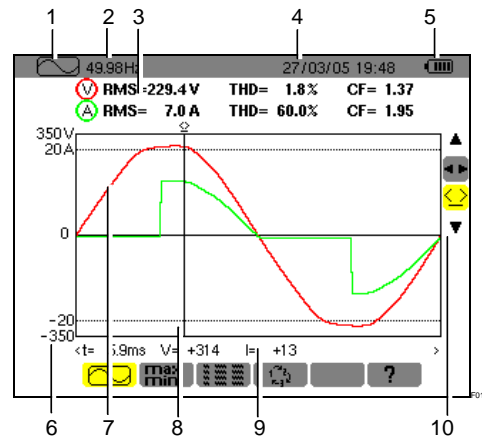





Figure 19: The information of the Waveforms screen.

Item	Function
1.	Reminder of the mode used.
2.	Instantaneous network frequency (measurement range: 40Hz to 69 Hz).
3.	RMS: RMS AC values of the phase-to-earth voltage (600 V max) or of the phase-to-phase voltage (660 V max) and of the current (6,500 A max). THD: Total harmonic distortion level. CF: Peak factors.
4.	Current date and time.
5.	Battery charge level.
6.	Axis of current and voltage values with automatic scaling.
7.	Display of waveforms (voltage and current).
8.	Instantaneous measurement cursor displayed by selection of the tool (item 10). The values are available in the zone just below the curves (item 9). The cursor is moved using the \blacktriangleleft \blacktriangleright key.
9.	Instantaneous value of the signal at the intersection of the cursor (item 8) and the curves. t: time since beginning of period. V: instantaneous value of the voltage. I: instantaneous value of the current.

(table continued on page 16)

(table continued from page 15)

10.	Use ▲▼ to select a tool.
	 : tool for selection of the sub-menu using ◀▶.
	 : instantaneous measurement cursor management tool on a point of the curve. Use the ◀▶ keys to move the cursor on the time scale. The measurement zone (item 9) is refreshed. A long press on the ◀ or ▶ key causes a shift to rapid motion.

4.	Same information as described in point 3, but for the current.
5.	Current date and time.
6.	Battery charge level.
10.	Use ▲▼ to select a tool.
	 : tool for selection of sub-menu using ◀▶.
	 : tool to reset the Max and Min displayed, as soon as the ↵ key is pressed. Immediate display of the new values.

5.3 Max - Min

This function displays the maximum, minimum, and mean values (RMS over half-period) of the voltage and current, and those of the positive and negative instantaneous peaks of the voltage and current. The information displayed is:

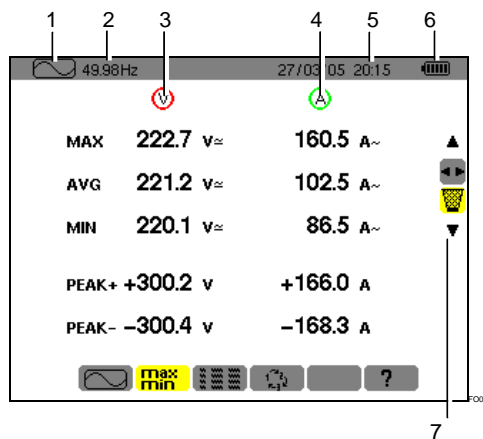



Figure 20: The information of the Max-Min screen.

Item	Function
1.	Reminder of the mode used.
2.	Instantaneous network frequency (measurement range: 40Hz to 70Hz).
3.	Column of voltage-related values. Max : true half-period RMS value of the AC voltage measured since the power up of the C.A 8230 or since the last selection of the  tool. Calculation every half-period (i.e. every 10 ms for a 50Hz signal). AVG : true RMS voltage of the signal calculated over one second. Min : true minimum half-period RMS value of the AC voltage measured since the power up of the C.A 8230 or since the last selection of the  tool. Calculation every half-period (i.e. every 10 ms for a 50Hz signal). Peak + : positive instantaneous peak value of the waveform. Peak - : negative instantaneous peak value of the waveform.

5.4 Simultaneous display

This function displays all of the voltage and current measurements (RMS, DC, THD, CF, PST, KF, DF). The information displayed is read as follows.

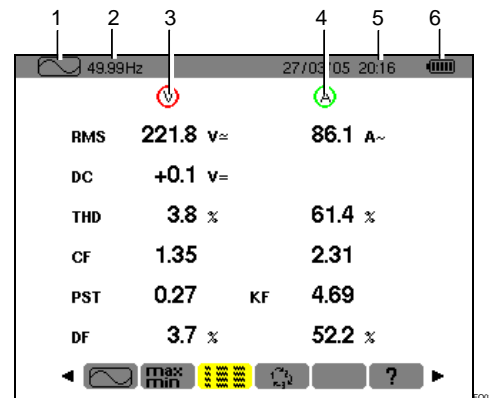

Figure 21: The information of the Simultaneous display screen.

Item	Function
1.	Reminder of the mode used.
2.	Instantaneous network frequency (measurement range: 40Hz to 70Hz).
3.	Column of voltage-related values. RMS : true RMS value calculated over 1 second. DC : offset (DC component). THD : level of total harmonic distortion (also called THD-F). CF : peak factor calculated on the waveform displayed. PST : short-term flicker (over 10 minutes). DF : distortion factor (also called THD-R).

(table continued on page 17).

(table continued from page 16)

4.	Column of current-related values. RMS: RMS value calculated over 1 second (the RMS value of the current is true - with DC component - only with a PAC and E3N sensors). THD: level of total harmonic distortion (also called THD-F). CF: peak factor calculated on the waveform displayed. DC: DC component of the current, with PAC and E3N sensors only. KF: K factor. Gives an indication of the sum of the current harmonics and can help in choosing a transformer. DF: distortion factor (also called THD-R).
5.	Current date and time.
6.	Battery charge level.

5.5 Phase rotation

This sub-menu determines the phase order of a three-phase network in three steps. The order of the phases can be determined in either the single-phase or the balanced three-phase connection mode.

5.5.1 Step 1

1. Connect the 2 voltage measurement cables to inputs **Com** and **+** of the C.A 8230 and place the contact tips on the phases assumed to be L1 and L2.
2. The screen displays the procedure ...

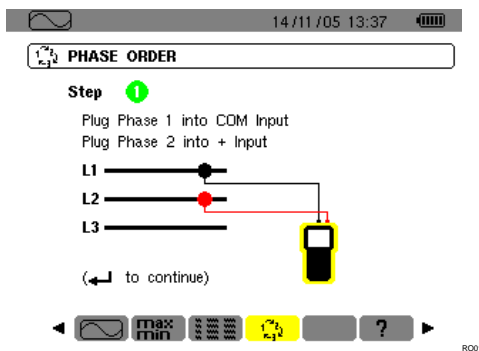

Figure 22: Step 1 of Phase rotation.

... press the \leftarrow key.

3. The screen indicates that the measurement is in progress.

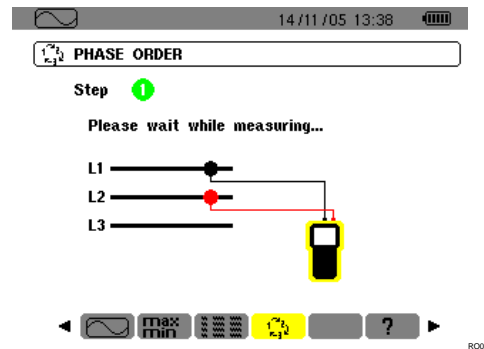

Figure 23: The screen during the measurement.

5.5.2 Step 2

The screen displays step 2 ...

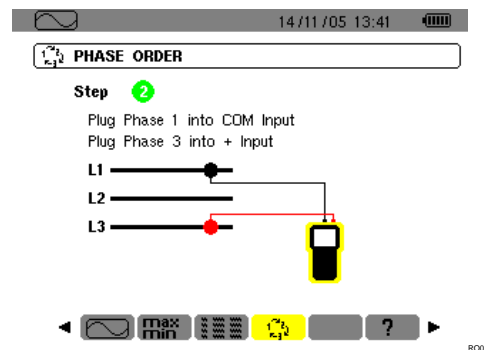

Figure 24: Step 2 of Phase rotation.

... place the red contact tip on the phase assumed to be L3. Do not press any other key; wait for the result of the measurement as indicated in step 3.

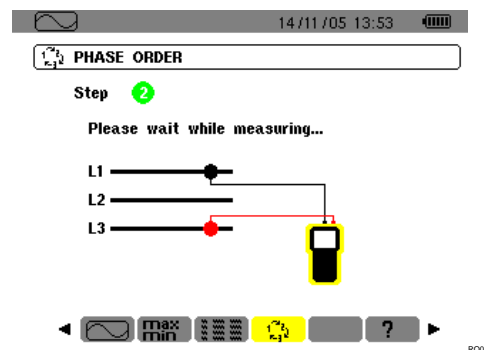

Figure 25: The measurement is in progress.

5.5.3 Step 3

The screen indicates the order of the phases.

Reverse sequence is displayed

The phase assumed to be L3 leads the phase assumed to be L2, which itself leads the phase assumed to be L1.

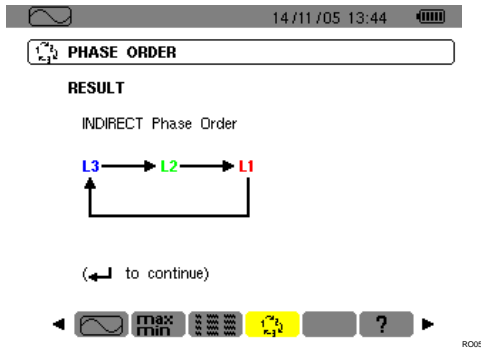

Figure 26: Example of the result of a measurement of an reverse phase sequence.

Forward sequence is displayed

The phase assumed to be L1 leads the phase assumed to be L2, which itself leads the phase assumed to be L3.

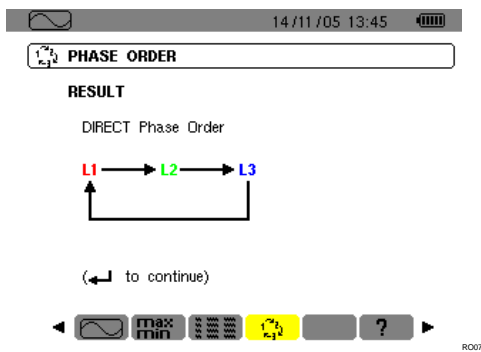

Figure 27: Example of the result of a measurement of a forward phase sequence.

5.5.4 Error messages

If the measurement is impossible, a warning message is displayed.

Waiting time exceeded

A maximum time of 10 seconds is allowed between steps 1 and 2.

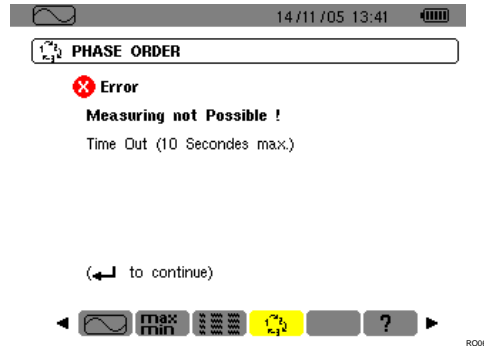

Figure 28: Waiting time exceeded.

Frequency out of bounds or signal too weak

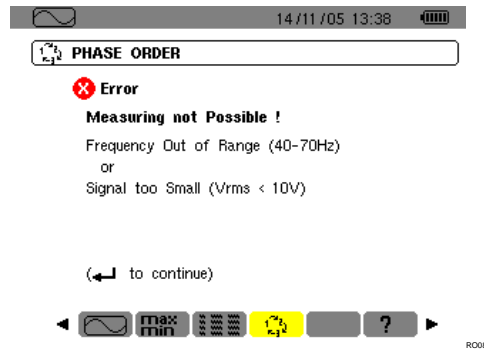

Figure 29: Frequency out of bounds or signal too weak.

6. **W** KEY (Powers and energies)

This key is used to display power- and energy-related measurements.

6.1 Sub-menus available

These are listed in the screen below and described individually in the sections that follow.

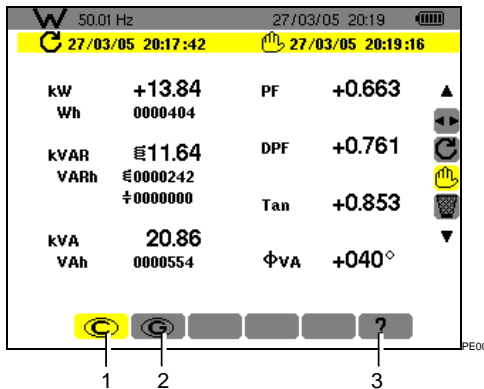

Figure 30: Example of display of Power and energy measurements.

Item	Sub-menus	See §
1.	Display of energies consumed.	6.2
2.	Display of energies generated.	6.3
3.	On-line help in this mode.	

Note: in the case of a balanced three-phase connection (selection in *Configuration of Connection / Balanced three-phase*, see § 4.7, page 11), a 3 ϕ symbol is displayed in the top bar of the screen. The measurements displayed are then measurements of the balanced three-phase network. The powers and energies are measured on the phase in question and multiplied by 3. The other measurements are unchanged.



Figure 31: The 3 ϕ sign at the top of the screen indicates a three-phase configuration.

6.2 **C** Energies consumed

This sub-menu displays, over a period of time defined by the operator:

- The active power.
- The reactive powers (capacitive or inductive).
- The apparent power.

Note: in the case of a balanced three-phase connection (selection in *Configuration of Connection / Balanced three-phase*), a 3 ϕ symbol is displayed in the top bar of the screen. The energies and powers displayed are then the total energies and powers of

the balanced three-phase network. The other measurements are unchanged.

6.2.1 Start of energy metering

1. Using the **▼** key, select the **C** tool (right-hand side of the display unit).

2. Press **↵** to start metering.

The top left of the screen displays the date and time of the beginning of the measurement:

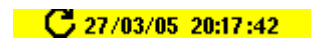

6.2.2 Energy metering

The energy meters start and total the various types of energy (the eight energy meters - 4 meters for energy consumed and 4 meters for energy generated - are started).

6.2.3 Stopping the energy metering

1. Using the **▼** key, select the **⏏** tool (right-hand side of the display unit).

2. Press **↵** to stop the metering.

The top right of the screen displays the date and time of the end of the measurement:

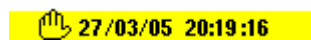

Note: Stopping is definitive. It is impossible to restart. All eight energy meters are stopped.

6.2.4 Reading of energy metering

The measurements are interpreted as follows

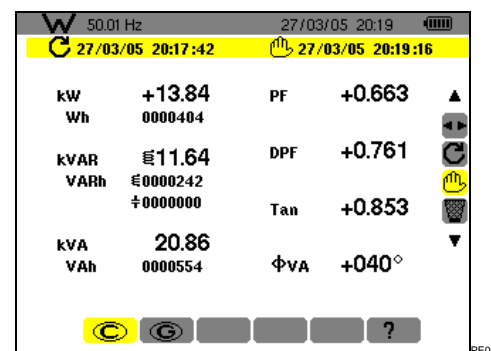





Figure 32: Example of display of power and energy measurements after metering.

Unit	Function
W	Active power.
Wh	Active energy consumed.
VAR	Reactive power: <ul style="list-style-type: none"> ⊖ Inductive. ⊕ Capacitive.
VARh	Reactive energy consumed.

	Inductive.
	Capacitive.
VA	Apparent power.
VAh	Apparent energy consumed.
PF	Power factor (ratio of active power to apparent power).
DPF	Displacement factor (cosine of ϕ).
Tan	Tangent of angle ϕ .
ϕ	Phase shift of the phase-to-earth voltage with respect to the phase-to-earth current.

6.2.5 Resetting energy metering

1. Select the  tool (right-hand side of the display unit).
2. Press \leftarrow to reset the metering.
All energy values are reset, including the energies generated (see § 6.3). The eight energy meters are reset.

6.3 Energies generated

This sub-menu displays, over a period of time defined by the operator:

- The active power.
- The reactive powers (capacitive or inductive).
- The apparent power.

Note: in the case of a balanced three-phase connection (selection in *Configuration of Connection / Balanced three-phase*), a 3ϕ symbol is displayed in the top bar of the screen. The energies and powers displayed are then the total energies and powers of the balanced three-phase network. The other measurements are unchanged.

6.3.1 Starting energy metering

1. Using the \blacktriangledown key, select the  tool (right-hand side of the display unit).
2. Press \leftarrow to start the metering.
The top left of the screen displays the date and time of the beginning of the measurement:

 27/03/05 20:17:42

6.3.2 Energy metering

The energy meters start and total the various types of energy (the eight energy meters - 4 meters for energy consumed and 4 meters for energy generated - are started).

6.3.3 Stopping the energy metering

1. Using the \blacktriangledown key, select the  tool (right-hand side of the display unit).
2. Press \leftarrow to stop the metering.

Note: Stopping is definitive. It is impossible to restart. All eight energy meters are stopped.

The top right of the screen displays the date and time of the end of the measurement:

 27/03/05 20:19:16

6.3.4 Reading of energy metering

The measurements are interpreted as follows

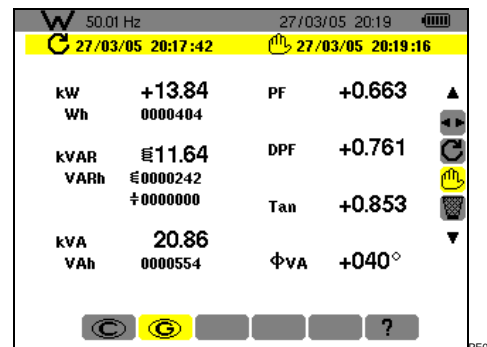







Figure 33: Example of display of power and energy measurements after metering.

Unit	Function
W	Active power.
Wh	Active energy generated.
VAR	Reactive power:  Inductive.  Capacitive.
VARh	Reactive energy generated:  Inductive.  Capacitive.
VA	Apparent power.
VAh	Apparent energy generated.
PF	Power factor (ratio of active power to apparent power).
DPF	Displacement factor (cosine of ϕ).
Tan	Tangent of angle ϕ .
ϕ	Phase shift of the phase-to-earth voltage with respect to the phase-to-earth current.

6.3.5 Reset of energy metering

1. Using the \blacktriangledown key, select the  tool (right-hand side of the display unit).
2. Press \leftarrow to reset the metering.
All energy values are reset, including the energies consumed (see § 6.2). The eight energy meters are reset.

Note: see the 4-quadrant diagram of powers in § 15.4, on page 48.

7. KEY (Harmonics)

This key displays the levels of harmonics of the voltage, current, and apparent power by order. It can be used to determine the harmonic currents produced by nonlinear loads and analyse the problems engendered by these harmonics as a function of their order (heating of the neutral, of the conductors, of the motors, etc.).

7.1 Sub-menus available

These are listed in the screen below and described individually in the sections that follow.

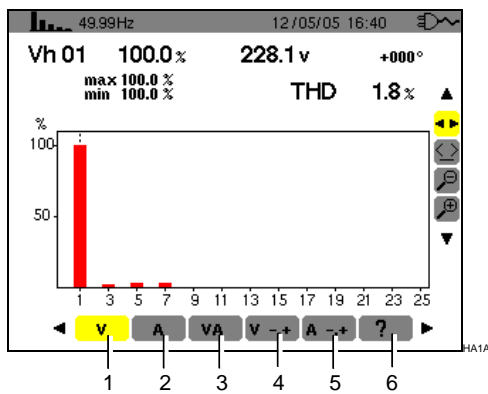

Figure 34: Example of display of Harmonics.

Item	Sub-menus	See
1.	Analysis of the harmonics of the voltage.	7.2
2.	Analysis of the harmonics of the current.	7.3
3.	Analysis of the harmonics of the apparent power (*).	7.4
4.	Sequences of voltage harmonics (*).	7.5
5.	Sequences of current harmonics(*).	7.6
6.	On-line help in this mode.	

(*): these sub-menus are not available with a balanced three-phase connection.



Figure 35: The 3 ϕ sign at the top of the screen indicates a three-phase configuration.

7.2 Voltage

This sub-menu displays the harmonics of the voltage. The information displayed is read as follows.

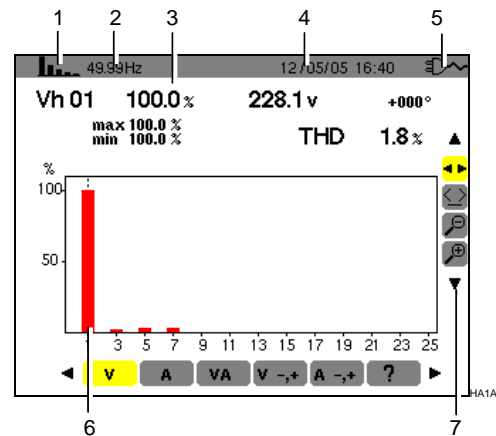
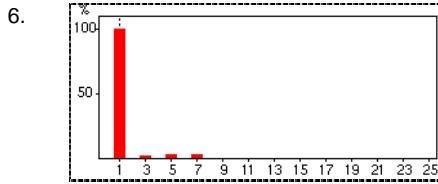

Figure 36: Example of display of harmonics of the voltage.

Item.	Function
1.	Reminder of the mode used.
2.	Instantaneous frequency.
3.	<div style="border: 1px dashed black; padding: 5px; margin-bottom: 10px;"> <p>Vh 01 100.0% 228.1 v +000° max 100.0 % min 100.0 % THD 1.8%</p> </div> <p>This information concerns the harmonic located under the cursor (see item 7).</p> <p>Vh xx: number of the harmonic.</p> <p>%: level of the harmonic with respect to the fundamental (order 1).</p> <p>v: RMS voltage of the harmonic in question.</p> <p>+000: phase shift with respect to the fundamental (order 1).</p> <p>Max – Min: indicators of the maximum and minimum of the level of the harmonic in question (reset at each change of harmonic number).</p> <p>THD: total harmonic distortion (also called THD-F).</p>
4.	Current date and time.
5.	Battery charge level.

Table continued on page 22.



The horizontal axis indicates the orders of the harmonics.

Display of the levels of the harmonics as a percentage with respect to the fundamental (order 1).

Order 0: DC component.

Order (1 to 25): order of the harmonics. As soon as the cursor goes past order 25, the range from 26 to 50 appears.

Note: the ► icon to the right of harmonic 25 indicates the presence of harmonics of order higher than 25.

7. Use ▲▼ to select a tool.



: sub-menu selection tool.



: bar chart cursor management tool. Use the ◀▶ keys to move the cursor from harmonic to harmonic. The measurement zone (item 3) is refreshed. A long press on the ◀ or ▶ key causes a shift to rapid motion.



: 'zoom out' tool. Each press on ↵ increases the vertical scale.



: 'zoom in' tool. Each press on ↵ decreases the vertical scale.

7.3 **A** Current

This sub-menu displays the harmonics of the current. The information displayed is read as follows.

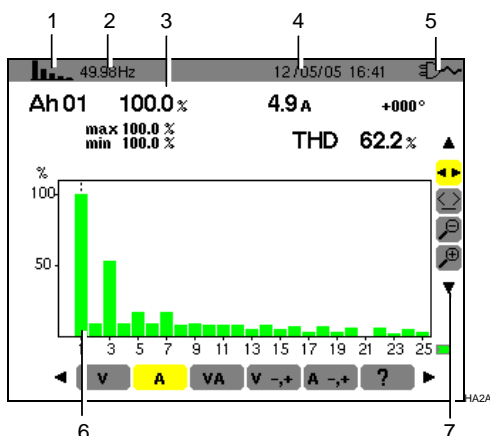

Figure 37: Example of display of the harmonics of the current.

Item Function

1. Reminder of the mode used.

2. Instantaneous frequency.

3. **Ah01 100.0% 4.9A +000°**
max 100.0%
min 100.0%
THD 62.2%

This information concerns the harmonic located under the cursor (see item 7).

Ah xx: number of the harmonic.

%: level of the harmonic with respect to the fundamental (order 1).

A: RMS current of the harmonic in question

+000: phase shift with respect to the fundamental (order 1).

Max - Min: indicators of the maximum and minimum of the level of the harmonic in question (reset at each change of harmonic number).

THD: total harmonic distortion (also called THD-F).

4. Current date and time.

5. Battery charge level.

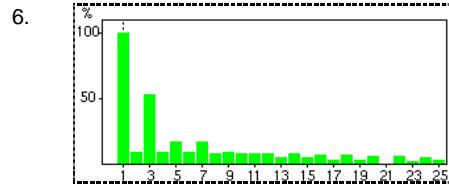

The horizontal axis indicates the orders of the harmonics.

Display of the levels of the harmonics as a percentage with respect to the fundamental (order 1).

Order 0: DC component (with PAC and E3N clips only).

Order (1 to 25): order of the harmonics. As soon as the cursor goes past order 25, the range from 26 to 50 appears.

Note: the ► icon to the right of harmonic 25 indicates the presence of harmonics of order higher than 25.

7. Use ▲▼ to select a tool.



: sub-menu selection tool.



: bar chart cursor management tool. Use the ◀▶ keys to move the cursor from harmonic to harmonic. The measurement zone (item 3) is refreshed. A long press on the ◀ or ▶ key causes a shift to rapid motion.



: 'zoom out' tool. Each press on ↵ increases the vertical scale.



: 'zoom in' tool. Each press on ↵ decreases the vertical scale.

7.4 VA Apparent power

This sub-menu is not available for a balanced three-phase connection. For a single-phase connection, this sub-menu displays the harmonics of the apparent power. The information includes:

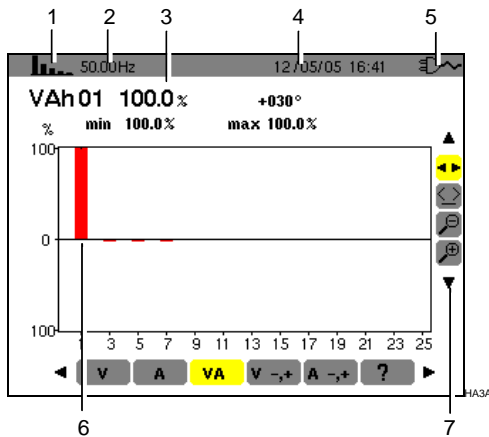

Figure 38: Example of display of the harmonics of the apparent power.

Item	Function
1.	Reminder of the mode used.
2.	Instantaneous frequency.
3.	<div style="border: 1px dashed black; padding: 5px; margin-bottom: 5px;"> VAh01 100.0% +030° % min 100.0% max 100.0% </div> <p>This information concerns the harmonic located under the cursor (see item 7).</p> <p>VAh xx: number of the harmonic.</p> <p>%: level of the harmonic with respect to the fundamental (order 1).</p> <p>+030°: phase shift of the voltage harmonic with respect to the current harmonic for the order in question.</p> <p>Min – Max: indicators of the maximum and minimum of the level of the harmonic in question (reset at each change of harmonic number).</p>
4.	Current date and time.
5.	Battery charge level.
6.	<div style="border: 1px dashed black; padding: 5px; margin-bottom: 5px;"> </div> <p>The axis horizontal indicates the orders of the harmonics (the bars of the chart that are above the horizontal axis represent harmonic power consumed, while those below it represent harmonic power generated).</p> <p>Display of the levels of the harmonics as a percentage with respect to the fundamental (order 1).</p> <p>Order 0: DC component ((with PAC and E3N</p>

clips only).

Order (1 to 25): order of the harmonics. As soon as the cursor goes past order 25, the range from 26 to 50 appears.

Note: the ► icon to the right of harmonic 25 indicates the presence of harmonics of order higher than 25.

7. Use ▲▼ to select a tool.

◀▶: sub-menu selection tool.

◀▶: bar chart cursor management tool. Use the ◀▶ keys to move the cursor from harmonic to harmonic. The measurement zone (item 3) is refreshed. A long press on the ◀ or ▶ key causes a shift to rapid motion.

🔍: 'zoom out' tool. Each press on ↵ increases the vertical scale.

🔍: 'zoom in' tool. Each press on ↵ decreases the vertical scale.

7.5 V -,+ Voltage expert mode

This sub-menu is not available for a balanced three-phase connection. For a single-phase connection, this sub-menu displays the *Voltage expert mode*. It concerns mainly rotating machines. This screen is used to classify the orders of voltage harmonics in 3 sequences: the "negative" sequence, the "zero" sequence, and the "positive" sequence. The information displayed is read as follows.

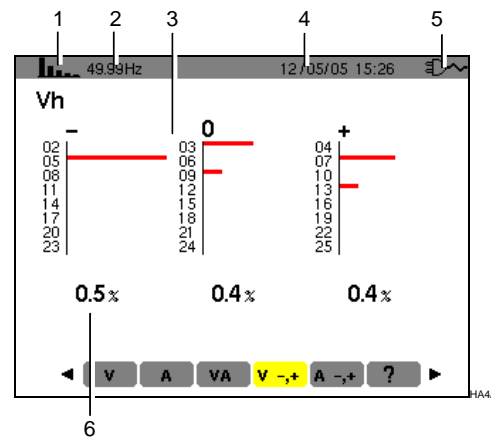

Figure 39: Example of display of voltage harmonics according to their effect.

Item	Function
1.	Reminder of the mode used.
2.	Instantaneous frequency.
3.	<div style="border: 1px dashed black; padding: 5px; margin-bottom: 5px;"> </div>

This information concerns the following elements:		
-: "negative" sequence.		
0: "zero" sequence.		
+: "positive" sequence.		
4.	Current date and time.	
5.	Battery charge level.	
6.	<div style="border: 1px dashed black; padding: 5px; display: flex; justify-content: space-around;"> 0.5% 0.4% 0.4% </div>	
Sums of the levels of "voltage" harmonics classified by sequence ("negative" to the left, "zero" in the centre, and "positive" to the right). See <i>Note</i> .		

7.6 A -,+ Current expert mode

This sub-menu is not available for a balanced three-phase connection. For a single-phase connection, this sub-menu displays the *Current expert* mode. It concerns mainly rotating machines. This screen is used to classify the orders of current harmonics in 3 sequences: the "negative" sequence, the "zero" sequence, and the "positive" sequence. The information displayed is read as follows.

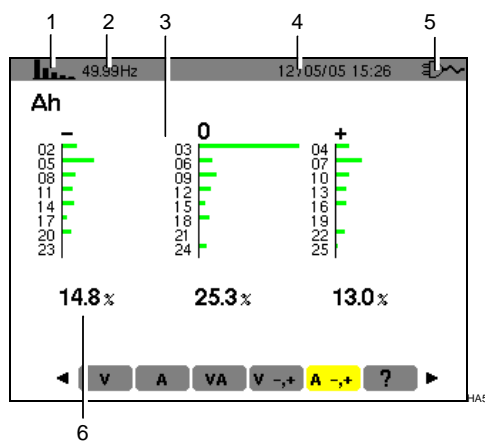
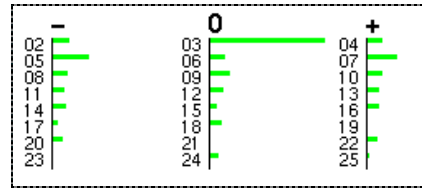

Figure 40: Example of display of current harmonics according to their effect.

Item	Function
1.	Reminder of the mode used.
2.	Instantaneous frequency.
3.	
This information concerns the following elements:	
-: "negative" sequence.	
0: "zero" sequence.	
+: "positive" sequence.	
4.	Current date and time.
5.	Battery charge level.
6.	<div style="border: 1px dashed black; padding: 5px; display: flex; justify-content: space-around;"> 14.8% 25.3% 13.0% </div>
Sums of the levels of "current" harmonics classified by sequence ("negative" to the left, "zero" in the centre, and "positive" to the right). See <i>Note</i> .	

Note: the effects of the sequences are the following:

- **"Negative" sequence**
 - Overheating of the rotating machine.
 - Loss of torque.
 - Mechanical oscillations.
 - Higher current draw for a given load.
 - Premature ageing of the rotating machine.
- **"Zero" sequence**
 - Overheating of the rotating machine.
 - Higher current draw for a given load.
 - Overload of the neutral.
 - Premature ageing of the rotating machine.

8. KEY (Screen grab)



This key can be used:



- To grab a maximum of 8 screens to be looked up later; refer to § 8.1.
- To display screen grabs recorded previously; refer to § 8.2.

The stored screens can then be transferred to a PC using the *DataViewer* application (see the corresponding manual).

8.1 Screen grab

To grab any screen , press  for 2 seconds.

The top left of the screen displays, in place of the icon for the active mode , the  icon, as soon as the screen grab is completed. The C.A 8230 has recorded the image.

Attention: the C.A 8230 can store a maximum of 8 screen grabs. A 9th screen grab is then impossible and an attempt at one leads to the display, at the top left of the screen, of the  icon in place of the  icon (item 1).

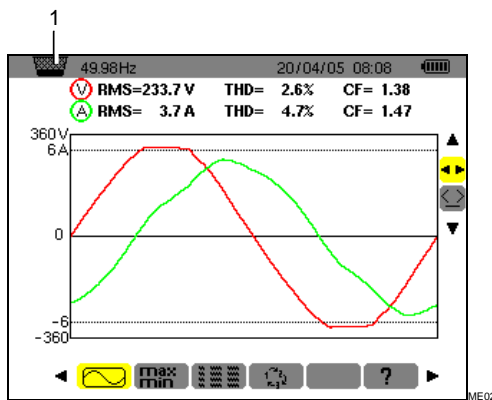





Figure 41: If the image memory is full, an attempted screen grab using the  key displays the wastebasket icon  (item 1).

8.2 Management of screen grabs

This management concerns stored screen grabs, namely:

- **Display** of the list of screen grabs (see § 0).
- **Display** of one of the screen grabs (see § 8.2.3).
- **Erasure** of one or more screen grabs (see § 8.2.4).

8.2.1 Functions available

To enter the screen grabs mode, press **briefly** on the  key.

Reminder: pressing the  key for 2 seconds triggers the screen grab function (§8.1).

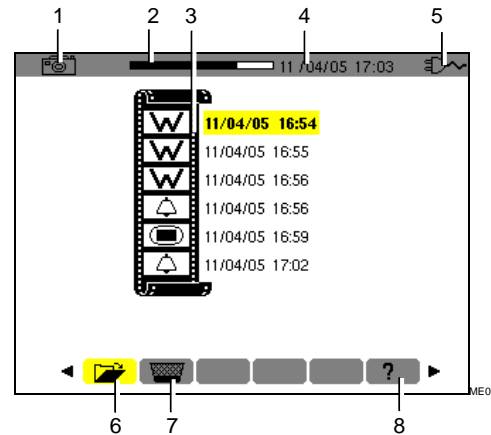



Figure 42: Example of display of a list of screen grabs.

Item	Function	See
1.	Reminder of the mode used.	
2.	Available image memory indicator. The black stripe represents the memory already in use, the white stripe the memory still available.	
3.	List of stored screen grabs: Each icon () indicates the type of screen stored (recording, alarm, waveforms, etc.) using the same icons as on the mode keys. It is followed by the date and time of the screen grab.	
4.	Current date and time.	
5.	Battery charge level.	
6.	Sub-menu for display of list of screen grabs (current sub-menu).	0
7.	Sub-menu for erasure of a screen grab.	8.2.4
8.	Sub-menu for on-line help in this mode.	

8.2.2 Display of the list of screen grabs

From any active function, press the  key briefly.

The display unit presents a list of stored screen grabs (Figure 42).

8.2.3 Display of a screen grab from the list

Proceed as follows:

1. With the screen listing the screen grabs displayed (Figure 42), check that the  sub-menu (bottom of screen) is selected.
2. Select the screen grab to be displayed using ▲▼.
3. Press ↵ to display the selected screen grab.
4. Return to the list of screen grabs (Figure 42) by ↵.

8.2.4 Erasure of a screen grab from the list

Proceed as follows:

1. With the screen listing the screen grabs displayed (Figure 42), select the  sub-menu (bottom of screen) using ◀▶.
2. Select the screen grab to be erased using ▲▼.
3. Press ↵ to erase the selected screen grab.
The screen grab is erased in the list of screen grabs.

9. KEY (Search for alarms)

This mode detects crossings of the thresholds of the values (Vrms, Arms, VPST, Vcf, Acf, Hz, Akf, Vthd, Athd, W, VAR, VA, DPF, PF, Tan, Vh, Ah and VAh) the user has chosen to supervise. These values to be supervised:

- Were defined using the *Configuration / Alarm* screen (see § 4.10, page 13).
- Must have **ON** status in this same screen.

The stored alarms can then be transferred to a PC using the *DataViewer* application (see the corresponding manual).

9.1 Sub-menus available

These are listed in the screen below and described individually in the sections that follow.

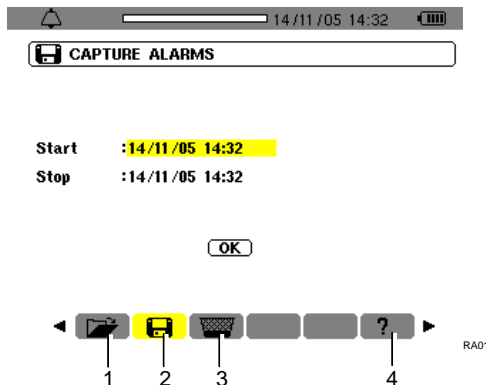

Figure 43: The screen when the Search for alarms mode is invoked.

Item	Sub-menus	See
1.	Display of the alarms log.	9.3
2.	Programming of the campaign of recording of detected alarms.	9.2
3.	Complete erasure of the alarms log.	9.4
4.	On-line help in this mode.	

9.2 Programming of a campaign of alarms

This sub-menu is used to define the starting and ending times of a campaign of alarms.

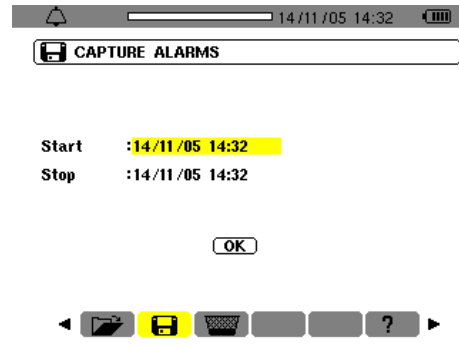

Figure 44: Parameterising the starting and ending times of a campaign of alarms.

9.2.1 Step 1: Parameterising the starting and ending times

To program the starting and ending times of a campaign of alarms, proceed as follows:

1. **With the *Start* field highlighted in yellow, press \leftarrow to define the starting date and time of the campaign of alarms.**

Use the \uparrow \downarrow keys to increment or decrement a value and \leftarrow \rightarrow to move to the adjacent item.

Note: the starting date and time must be later than the current date and time.

Press \leftarrow once the programming of the *Start* is completed.

2. **Select *End* using \downarrow and press \leftarrow to define the ending date and time of the campaign of alarms.**

Use the \uparrow \downarrow keys to increment or decrement a value and \leftarrow \rightarrow to move to an adjacent item.

Note: the ending date and time must be later than the starting date and time.

Press \leftarrow once the programming of the *End* is completed.

3. **Press \downarrow again to highlight the *OK* zone in yellow.**

9.2.2 Step 2: Starting the campaign of alarms

To start the campaign of alarms between the starting and ending times, with the *OK* key yellow (**OK**), press \leftarrow to start the campaign of alarms.

- The *OK* button disappears.
- The message *Waiting to start search* is displayed at the bottom of the screen while waiting for the starting time.

- At the starting time, the bottom of the screen displays *Search in progress*.
- At the ending time, the **OK** key is displayed again on a yellow ground (**OK**).

9.2.3 Voluntary stoppage of the campaign of alarms

The campaign of alarms can be stopped voluntarily (terminated) before the ending date and time by selecting the  tool (icon on right side of screen) by pressing **▼** and pressing **↵**.

9.3 Display of the alarms log

This sub-menu displays the alarms log. The log can contain up to 4,096 alarms. To display this alarms log, select the  sub-menu using **◀**.

Note: this log groups all alarms generated by the various campaigns. Only the timestamping differentiates the campaigns.

The *Display alarms* screen is displayed. Use the **▲▼** key to move chronologically in the alarms log.

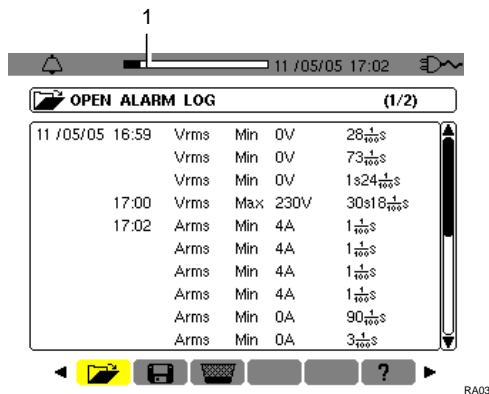

OPEN ALARM LOG (1/2)					
11/05/05	16:59	Vrms	Min	0V	28 $\frac{1}{1000}$ s
		Vrms	Min	0V	73 $\frac{1}{1000}$ s
		Vrms	Min	0V	1s24 $\frac{1}{1000}$ s
	17:00	Vrms	Max	230V	30s18 $\frac{1}{1000}$ s
	17:02	Arms	Min	4A	1 $\frac{1}{1000}$ s
		Arms	Min	4A	1 $\frac{1}{1000}$ s
		Arms	Min	4A	1 $\frac{1}{1000}$ s
		Arms	Min	0A	90 $\frac{1}{1000}$ s
		Arms	Min	0A	3 $\frac{1}{1000}$ s

Figure 45: Example of results after a campaign of alarms. The zone (item 1) displays the level of filling of the alarms log; the black cursor represents the memory already in use.

The information is read as follows:

- Date and time of the alarm.
- Parameter supervised (Vrms, etc.).
- Amplitude (min. or max.). The values recorded in W, VAR, PF DPF and $\tan \phi$ are recorded in absolute value.
- Duration of the alarm.

9.4 Erasure of the alarms log

This sub-menu erases the whole log. To erase the log, proceed as follows:

- Select the  sub-menu using **◀▶**.
The *Erase all alarms* screen is displayed.
- Select **Yes** using **▲▼**.

To exit from this screen without erasing the stored data, select **No** using **▲▼** and press **↵**.

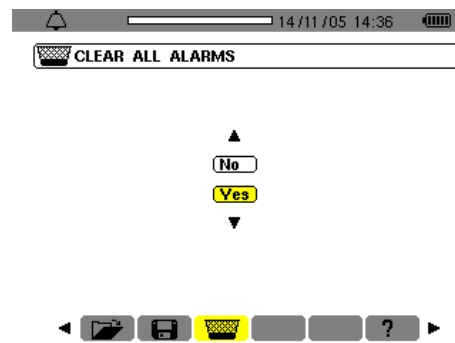

Figure 46: The Erase all alarms screen.

- To validate the erasure of the log (all alarms), press **↵**.

The log is empty.

The return to the *Display alarms* screen is automatic.

10. KEY (Record)

This mode records the evolution of the parameters previously defined in the *Configuration / Recording* screen (§ 4.9, page 12).

10.1 Sub-menus available

These are listed in the screen below and described individually in the sections that follow.

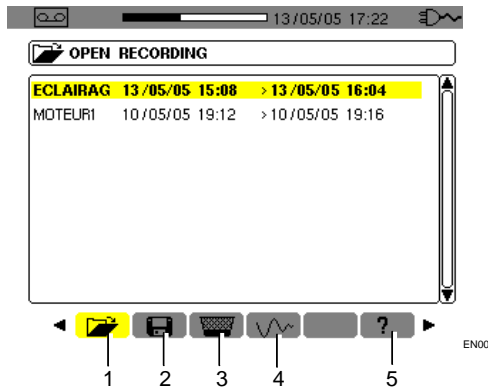



Figure 47: The screen when the Record mode is invoked.

Item	Sub-menu	See
1.	Display of recording.	10.5
2.	Parameterising and starting of a recording campaign.	10.2
3.	Erasure of a recording campaign.	10.7
4.	<i>Inrush</i> mode.	10.8
5.	On-line help in this mode.	

10.2 Parameterising and starting of a recording campaign

10.2.1 Step 1: Parameterising the characteristics

This sub-menu is used to define the characteristics of a new recording campaign. Proceed as follows:

1. Select the  sub-menu using the ► key.
2. Select the **Configuration** to be used.
To do this, press ← and use ▲▼. Press ← to validate.

Reminder: configurations **CONFIG 1** to **CONFIG 4** were defined in the *Configuration / Recording* screen (§ 4.9, page 12).

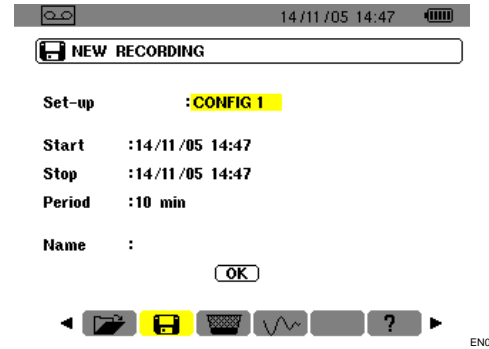

Figure 48: Example screen for configuration of new recording.

3. Select **Start** using ▼. Press ← to define the starting date and time of the recording campaign.

Use the ▲▼ keys to increment or decrement a value and ◀▶ to move to an adjacent item.

Note: the starting date and time must be later than the current date and time.

Press ← once the programming of the *Start* is completed.

4. Select the **End** field using ▼ and press ← to define the ending date and time of the recording campaign.

Use the ▲▼ keys to increment or decrement a value and ◀▶ to move to an adjacent item.

Note: the ending date and time must be later than the starting date and time.

Press ← once the programming of the *End* is completed.

5. Select the **Period** field using ▼ and press ← to define the duration of integration of the records of the campaign.

Use the ▲▼ keys to increment or decrement the possible values (1s, 5s, 20s, 1mn, 2mn, 5mn, 10mn, or 15mn). Press ← to validate.

Note: the recording integration period is the time over which the measurements of each value recorded will be averaged.

6. Press ▼ again to highlight the **Name** zone in yellow and press ← to enter the edit mode.

Enter the name of the record, for example MOTEUR1. Several records may have the same name.

The alphanumeric characters available are A...Z, space, and 0 to 9. Use the ▲▼ key to display a character and ◀▶ to move to an adjacent character.

Press ← once the programming of the *Name* is complete.

7. Press ▼ to reach the **OK** zone. Press ← to start the recording campaign.

The starting and ending times will be adjusted automatically according to the period chosen.

The C.A 8230 calculates the memory needs in real time and if necessary displays the message *Not enough memory*.

If the starting and ending points are incompatible with one another or with the current time, the cursor moves to the field to be corrected. Follow the corresponding procedure.

10.2.2 Step 2: Starting the recording campaign

As soon as the OK key is pressed (point 7 of step 1 above) the recording campaign is pending (the OK button disappears and the bottom of the screen indicates *Waiting to record*) until the system date and time matches the programmed starting date and time.

The bottom of the screen then indicates *Recording in progress*. The measurements are averaged over the *Period* defined and then recorded; the value of this period will match the value displayed when the recording is later looked up (see § 10.5, step 3).

The top of the screen displays a black stripe (item 1) representing the time already elapsed (black zone) with respect to the total time (white zone) of the recording in progress.

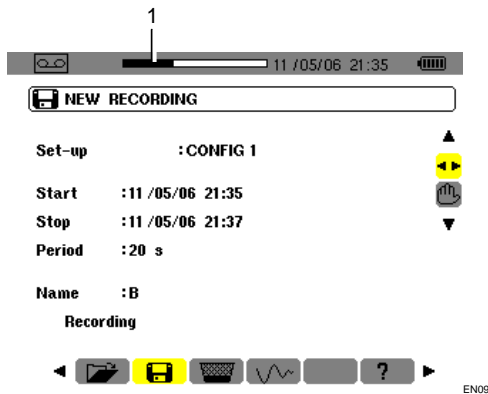



Figure 49: The black stripe indicates the time elapsed with respect to the total duration of the recording in progress.

10.3 Voluntary stoppage of the recording campaign

It is possible to stop a recording campaign in progress definitively, and therefore with no possibility of resumption, before the date and time programmed on the End line, by pressing ▼, selecting the  tool (icon on the right side of the screen), and pressing ↵. The measurements made from the Starting date and time up to this time are stored and can be looked up (see § 10.5).

10.4 Automatic stopping of the recording campaign

The recording campaign stops automatically at the date and time defined on the End line. The bottom of the screen stops displaying the *Recording in progress* message. It is then possible to look up the

stored measurements (see § 10.5) or to program another campaign (see § 10.2).

10.5 Viewing a recording

Proceed as follows:

1. Select the  sub-menu using the ◀ key. The screen displays the various stored recording campaigns.

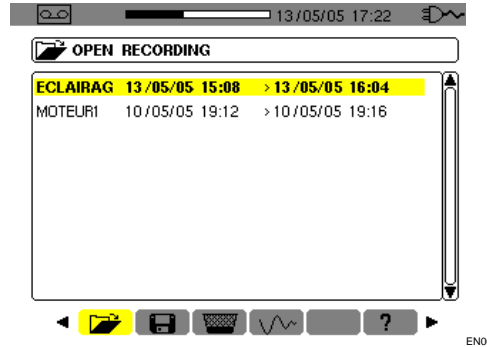

Figure 50: Example of recording campaigns screen.

2. Select the recording campaign to be looked up. Use ▲▼ and validate using ↵.
3. In the screen displayed, select the measurement recording to be displayed. Use ▲▼ and validate using ↵.

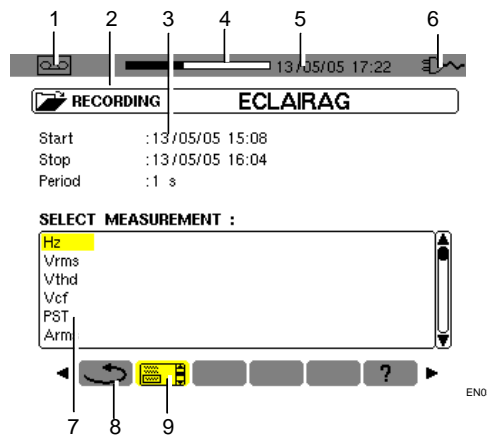

Figure 51: Example of measurement recording selection screen.

Item	Function
1.	Reminder of the mode used.
2.	Reference of the record.
3.	Date and time and integration period of the record.
4.	Total memory used (black zone) and memory available (white zone).
5.	Current date and time.
6.	Battery charge level.
7.	Measurement recordings available in the form of curves (Figure 52).
8.	Return to the previous screen (Figure 50).
9.	Current screen.

4. The screen corresponding to the measurement recording selected is displayed.

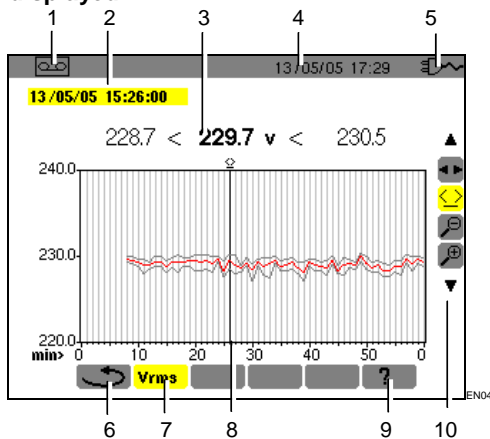



Figure 52: Example of measurement recording screen.

Item	Function
1.	Reminder of the mode used.
2.	Date and time corresponding to the position of the time cursor.
3.	Minimum, mean, and maximum measurements recorded in the display integration period corresponding to the position of the cursor. Note: for VRMS and ARMS only, the minimum and maximum values correspond to the RMS values for a half-period. A long press on the ◀ or ▶ key causes a shift to rapid motion if the ⏏ tool is selected.
4.	Current date and time.
5.	Battery charge level.
6.	Return to previous screen (Figure 51).
7.	Reminder of the type of measurement.

8.	Cursor that can be moved by ◀▶ when the ⏏ tool is selected (see point 10 of this same table).
9.	On-line help in this mode.
10.	Use ▲▼ to select a tool. ⏏: sub-menu selection tool. ⏏: time cursor management tool. Use the ◀▶ key to move the cursor on the time scale. The measurement zone is refreshed. 🔍: 'zoom out' tool. Each press on ⇄ increases the scale of the horizontal time axis. 🔍⊕: 'zoom in' tool. Each press on ⇄ decreases the scale of the horizontal time axis.

5. Return to the previous screen  **using** ◀ **(the** ◀▶ **tool must be selected).**

Proceed as in point 3 for each of the measurements recorded.

It is possible to return to any mode by pressing the corresponding mode key (📷 📐 📊 📈 📉 📊 📈 📉).

10.6 Examples of recordings

10.6.1 Voltage (Vrms)

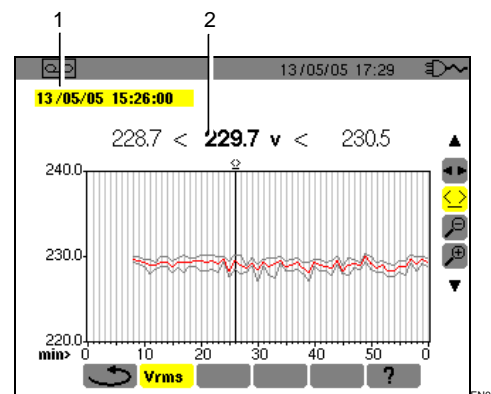

Figure 53: Example of Vrms measurement screen.

Item	Function
1.	Date and time corresponding to the position of the time cursor.
2.	Minimum, mean, and maximum measurements recorded in the display integration period corresponding to the position of the cursor. A long press on the ◀ or ▶ key causes a shift to rapid motion if the ⏏ tool is selected.

10.6.2 Current (Arms)

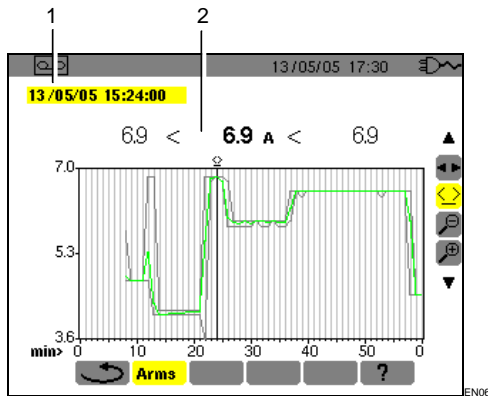

Figure 54: Example of Arms measurement screen.

Item	Function
1.	Date and time corresponding to the position of the time cursor.
2.	Minimum, mean, and maximum measurements recorded in the display integration period corresponding to the position of the cursor. A long press on the ◀ or ▶ key causes a shift to rapid motion if the ⏏ tool is selected.

10.6.3 Active power (W)

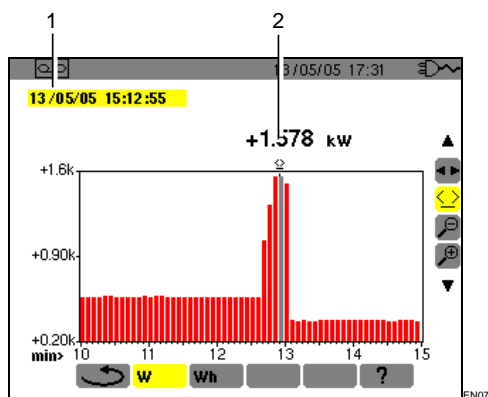

Figure 55: Example of active power measurement screen.

Item	Function
1.	Date and time corresponding to the position of the time cursor.
2.	Mean value in the active power display integration period corresponding to the position of the cursor. A long press on the ◀ or ▶ key causes a shift to rapid motion if the ⏏ tool is selected.

10.6.4 Energy in specified duration (Wh)

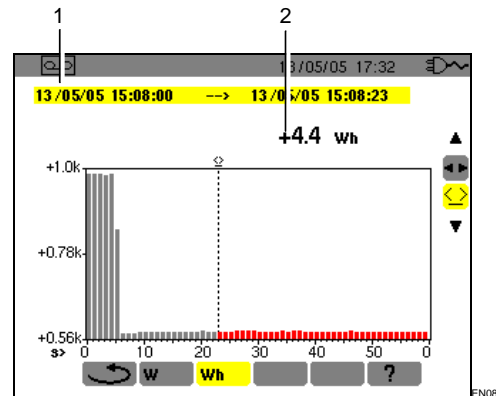

Figure 56: Example of energy measurement screen.

Item	Function
1.	Starting and ending dates and times of the energy calculation.
2.	Value of the energy from the starting date and time up to the cursor position (date and time of end of calculation). A long press on the ◀ or ▶ key causes a shift to rapid motion if the ⏏ tool is selected.

Proceed as follows:

- With the ⏏ tool selected, choose the starting date/time of energy metering using the ◀ ▶ keys.
- With the ⏏ tool selected, choose the Wh sub-menu using the ▶ key.
The screen displays the recording relevant to the energy measurement. The starting and ending dates are identical.
- Select the ⏏ tool using the ▼ key.
The time cursor is activated.
- Move the time cursor using the ◀ or ▶ key.
The energy between the starting date and time and the time cursor (ending date and time) is displayed (item 2). In addition, the corresponding bars of the bar chart turn grey.







Note: the 🗨 and 📏 tools are used both to change the display integration period of the measurement displayed and to change the time scale of the graph (table on next page).

Display integration period	Scale of the graph
2 hours	5 days
1 hour	2 1/2 days
15 minutes	15 hours
10 minutes	10 hours
5 minutes	5 hours
1 minute	1 hour
20 seconds	20 minutes
5 seconds	5 minutes
1 second	1 minute

10.7 Erasure of a recording campaign

Proceed as follows:

1. Select the  sub-menu using \leftarrow \rightarrow .
The *Erase a record* screen is displayed.
2. Select the recording campaign to be erased using \uparrow \downarrow .

To exit from this screen without any erasure, use the \leftarrow \rightarrow key or press a mode key (     .

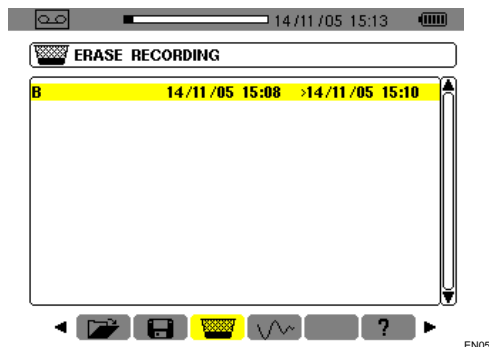







Figure 57: Erasure of a record.

3. Press \leftarrow .
Attention: the erasure takes one or two seconds to take effect.
4. Use the \leftarrow \rightarrow key or press a mode key (     ) to exit from the sub-menu.

10.8 Inrush mode (starting current)

This sub-menu is used to record the waveform of the current on 229,376 samples, at 256 samples per period (17.92s of recording for a 50Hz signal). Recording is triggered automatically when the starting of a motor is detected. The beginning of the motor starting search can be triggered in delayed mode (starting date and time programmed by the user). The search can be stopped manually when the operator judges it necessary. Once the recording has been done, the C.A 8230 displays the waveform of the current. The user can then move along the curve using a cursor and zoom in on features of interest.

The following information is available:

- Instantaneous value of the current at the time indicated by the cursor.
- Maximum instantaneous value of the current (over the entire start).
- RMS value of the half-period (or lobe) of the current on which the cursor is placed.
- Maximum half-period RMS value of the current (over the entire start).
- Starting time and duration of the starting of the motor.

Warning : the voltage must be present before the motor is switched on (in order to have a stable and correct frequency synchronization)

10.8.1 Define a new *Inrush* recording

1. Select the *Inrush* sub-menu  using the \rightarrow key.

The *inrush* Mode screen is displayed.

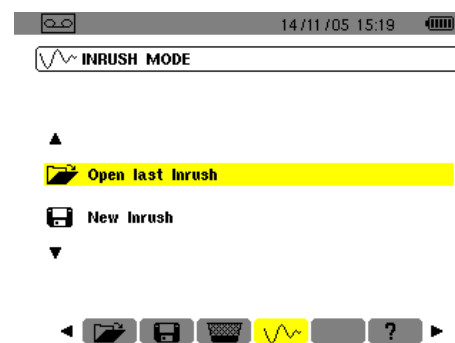

Figure 58: The *Inrush* Mode screen.

2. Select the **New recording** line and validate.
Use the \downarrow and \leftarrow keys.
3. Define the measurement values and validate.

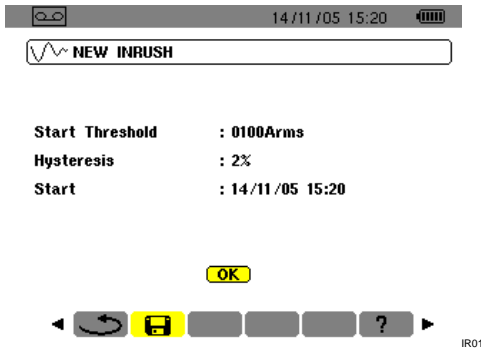

Figure 59: Parameterising of the Inrush recording.

Use the ▲▼ key to select a field, ↵ to enter the field, ▲▼ to increment or decrement the value in the field, ◀▶ to go from one selection to the other inside the field, and ↵ to exit from the edit mode.

- **Triggering threshold:** defines the threshold beyond which recording will be effected. Note: the triggering and stopping thresholds are half-period RMS current values.
- **Hysteresis:** determines, with the triggering threshold, the stopping threshold of *Inrush* recording. With a hysteresis of 2% and a triggering threshold of 1,000 A RMS, the stopping threshold will be 980 A RMS. Note: when the stopping threshold is not detected, recording continues until the memory is full. The maximum value is 5,999 A RMS.
- **Start:** defines the date and time after which the recording will be done.

10.8.2 Start *Inrush* recording.

Select OK and validate.

The message *Waiting for triggering threshold* is displayed at the bottom of the screen.

The current measurements *Inrush* will be recorded when the triggering threshold is reached. Recording will be stopped when the stopping threshold is reached.

10.9 🖱️ Voluntary stoppage of recording *Inrush*

The operator can terminate the recording of the starting current at any time. Proceed as follows:

1. Press ▼ to select the 🖱️ tool (icon on right side of screen).
2. Press ↵. The recording of the starting current is stopped.

10.10 Viewing the recording *Inrush*

Proceed as follows:

1. From the *New Inrush recording* (Figure 59), screen press ◀ to return to the *Inrush Mode* screen.
2. In the *Inrush Mode*, screen, press ↵. The *Display of last recording* line is already selected.

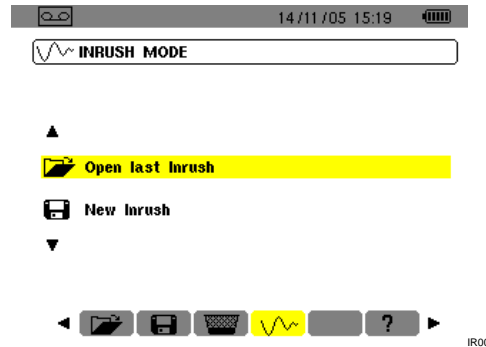

Figure 60: Selection of the display function.

3. In the *Display Inrush recording* screen, ...

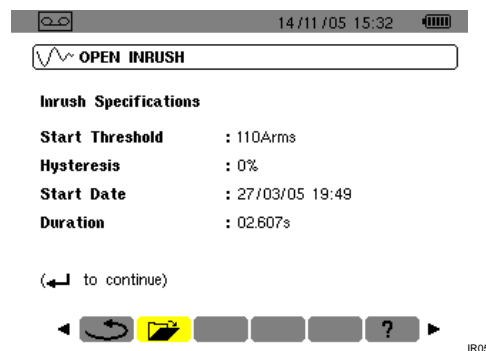

Figure 61: Reminder of the specifications of the *Inrush* recording.

4. ... press ↵ again.

The waveform of the recording is displayed.

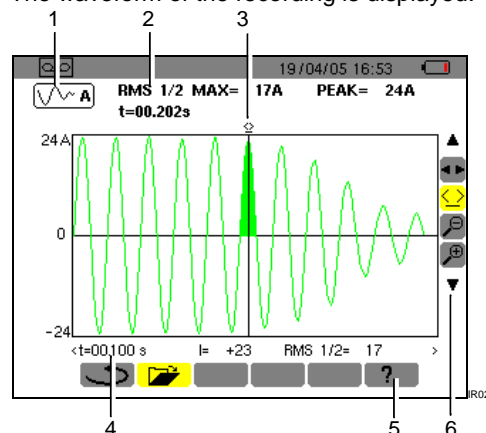







Figure 62: Display of a waveform.

See next page for explanation.

Item	Function
1.	Reminder of the mode used.
2.	<p>RMS ½ max: maximum half-period RMS value of the start.</p> <p>PEAK: maximum instantaneous value of the start.</p> <p>t: duration of the start.</p>
3.	<p>Cursor that can be moved using ◀▶ if the  tool is selected (see point 6 of this same table). The coloured zone corresponds to the lobe selected by the time cursor.</p>
4.	<p>t: relative position of the cursor in time (t=0 corresponds to the beginning of the start).</p> <p>I: instantaneous value of the current at the cursor position.</p> <p>RMS1/2: half-period RMS value at the cursor position.</p>
5.	On-line help in this mode.
6.	<p>Use ▲▼ to select a tool.</p> <p>: sub-menu selection tool.</p> <p>: tool for management of the instantaneous measurement cursor on a point of the curve. Use the ◀▶ key to move the time scale. The measurement zone (item 4) is refreshed. A long press on the ◀ or ▶ key causes a shift to rapid motion.</p> <p>: 'zoom out' tool. Each press on ↵ increases the horizontal time scale.</p> <p>: 'zoom in' tool. Each press on ↵ decreases the horizontal time scale.</p>

When the stopping threshold is not detected, the message "Stopping threshold not detected" is displayed

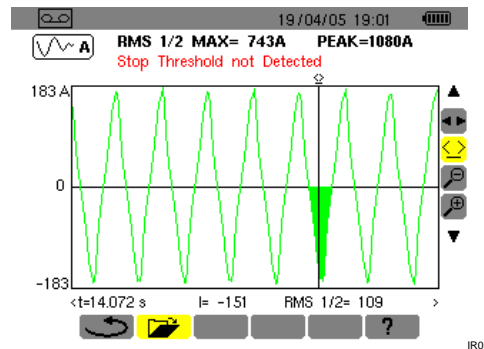



Figure 63: A message is displayed when the threshold is not detected.

A zoom on any zone of the starting current curve using the  and  tools is illustrated below.

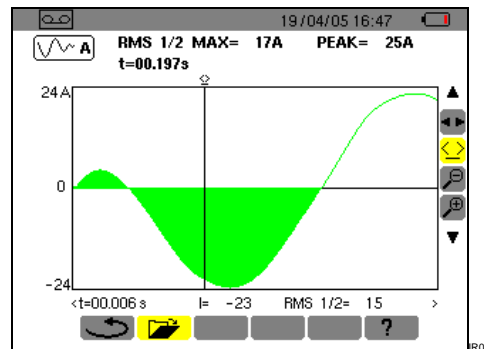

Figure 64: Maximum zoom on part of a waveform.

11. USE

Before the measurements are made, the C.A 8230 must be parameterised in accordance with chapter 4.

The following precautions of use must be observed:

- Do not connect a voltage exceeding 600V RMS with respect to earth.
- When installing or removing the storage batteries, make sure that the voltage measurement cords are disconnected.

11.1 Starting

Press the green  key.

A welcome page is displayed at first, while the application software is loading. Note the version number of the application software and the serial number of the C.A 8230 displayed at the bottom left of the screen.



Figure 65: The welcome screen at start-up.

After approximately 5 seconds the *Waveforms* screen is displayed.

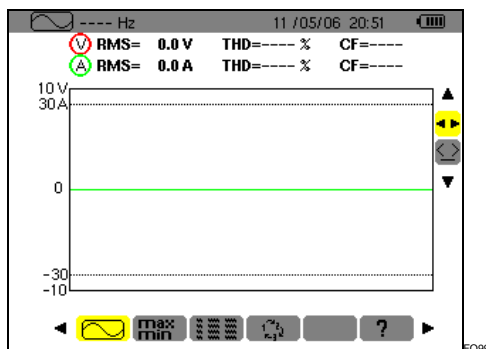



Figure 66: The Waveforms screen is displayed after the C.A 8230 is switched on.

The C.A 8230 operates on battery power only if the charge is sufficient; if not, an alarm message is displayed (see § 3.9.1, on page 7). The instrument can be used with the line power unit connected to the terminal (Figure 3, item 1); the internal storage batteries are not necessary in this case.

Attention: use the external mains power unit only in an environment where there is no explosion risk.

11.2 Configuring the C.A 8230

Proceed as follows:

1. **With the instrument in service, press the  key.**
The parameterising screen is displayed.
2. **Press the \blacktriangle / \blacktriangledown key to select the parameter to be modified. Press \leftarrow to enter the selected sub-menu.**

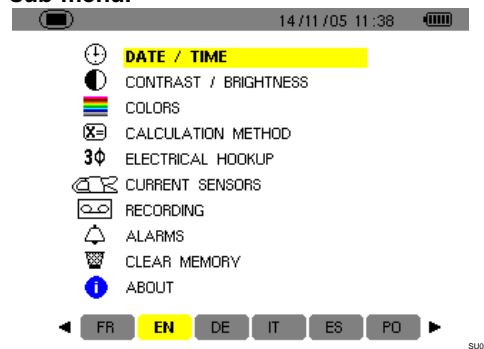

Figure 67: The Parameterising menu.

3. **In the sub-menu displayed, use the \blacktriangle / \blacktriangledown and \blacktriangleleft / \blacktriangleright keys to navigate and \leftarrow to validate.**
Refer to §§ 4.3 to 4.12 for details. However, the following points must be checked or adapted for each measurement:

Function	See §
Define the calculation parameters for reactive quantities.	4.6
Select the type of connection (single-phase or balanced three-phase).	4.7
According to the type of current sensor connected, program the transformation ratio or transduction ratio.	4.8
If necessary, values to be recorded.	4.9
If necessary, definition of the alarm thresholds.	4.10

4. **Return to the *Parameterising* screen using \leftarrow .**

11.3 Placing the cords

Insert the cords as follows:

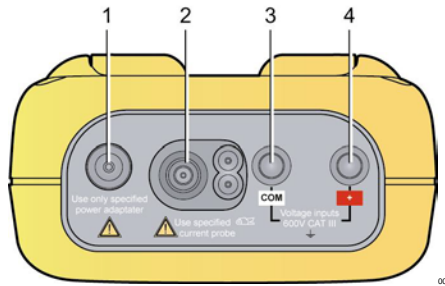

Figure 68: The connectors on the top.

Item	Function
1.	External power supply by specific mains power unit.
2.	4-point input for current sensor (MN clip, C clip, AmpFLEX, etc.).
3.	Safety socket of the voltage measurement cable (negative terminal).
4.	Safety socket of the voltage measurement cable (positive terminal).

Connect the measurement cords to the C.A 8230 as follows:

- Voltage measurement: COM and (+) terminals.
- Current measurement: 4-point connector (item 2). On the current sensor, do not forget to set the switch (if there is one) to a sensitivity that corresponds to the current to be measured.

The measurement cords are connected to the circuit to be studied as shown by the following diagrams.

11.3.1 Single-phase network

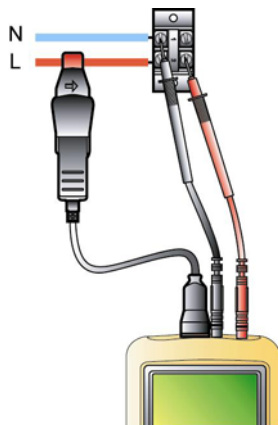

Figure 69: Single-phase connection. 005

11.3.2 Balanced three-phase network

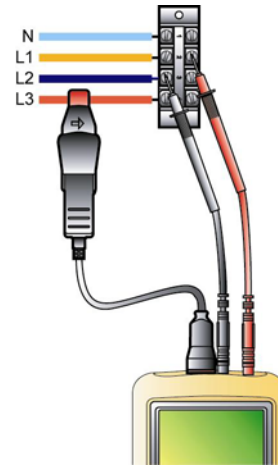



Figure 70: Balanced three-phase connection 006

Note: the neutral may or may not be present.

11.4 Measurement of waveforms

Reminder: any screen can be saved (screen grab) by pressing the  key. Refer to chapter 8, page 25.

With the C.A 8230 switched on and connected to the network (voltage and current measurement cords), press the  key.

11.4.1 Display of waveforms

Refer to § 5.2, page 15.

11.4.2 Display of min., max., peak

Refer to § 5.3, page 16.

11.4.3 Display of all measurements

To display all voltage and current measurements (RMS, DC, THD, CF, PST, KF, DF), refer to § 5.4, page 16.

11.4.4 Display of phase order

Refer to § 5.5, page 17.

11.5 Detection of alarms

Reminder: any screen can be saved (screen grab) by pressing the  key. Refer to chapter 8, page 25.

11.5.1 Configuration

Configure the values to be supervised as explained in § 4.10, page 13.

11.5.2 Starting

Use the function as explained in § 9.2, page 27.

11.5.3 Automatic stop

The alarm recording campaign is stopped automatically at the *Ending* date and time programmed by the operator.

11.5.4 Voluntary stop

Use the function as explained in § 9.2.3, page 28.

11.5.5 Viewing the alarms log

Refer to § 9.3 en page 28.

11.5.6 Erasing the alarms log

Erasure is not mandatory; it will be performed as needed. See § 9.4, page 28.

11.6 Recording

Reminder: any screen can be saved (screen grab) by pressing the  key. Refer to chapter 8, page 25.

11.6.1 Configuration

Configure the values to be supervised as explained in § 4.9, page 12.

11.6.2 Starting a recording campaign

Refer to § 10.2, page 29.

11.6.3 Viewing a recording

Refer to § 10.5, page 30.

11.7 Measurement of energies

Reminder: any screen can be saved (screen grab) by pressing the  key. Refer to chapter 8, page 25.

11.7.1 Measurement of energies consumed

First reset the meters (§ 0, page 20). Then refer to § 6.2, page 19.

11.7.2 Measurement of energies generated

First reset the meters (§ 0 page 20). Then refer to § 6.3, page 20.

11.8 Measurement of harmonics

Reminder: any screen can be saved (screen grab) by pressing the  key. Refer to chapter 8 page 25.

11.8.1 Voltage measurement

Refer to § 7.2, page 21.

11.8.2 Current measurement

Refer to § 7.3, page 22.

11.8.3 Measurement of apparent power

Refer to § 7.4, page 23.

11.8.4 Voltage expert measurement

Refer to § 7.5, page 23.

11.8.5 Current expert measurement

Refer to § 7.6, page 24.

11.9 Transferring data to a PC

The *DataViewer* transfer software automatically determines the speed of communication between the PC and the C.A. 8230. All measurements made by the C.A 8230 are stored. They can therefore be transferred to a PC and looked up later.

Note: the transfer does not erase the stored data.

11.10 Erasure of the data

The stored data can be erased before a new campaign of tests to free memory. Refer to § 4.11, page 14.

11.11 Stopping

This is done by pressing the green  key.

If, however, the C.A 8230 is recording (§ 10.2, page 29), stopping is possible only after confirmation; the message *Are you sure you want to switch off the instrument? Recording in progress. Yes - No* is displayed. Select *Yes* or *No* using the ◀▶ key.

- If *No* is selected, recording continues.
- If *Yes* is selected, the data recorded up to then are stored and the instrument is switched off.

11.12 Power supply of the C.A 8230

11.12.1 Recharging the battery

Refer to § 3.9.3, on page 8.

11.12.2 Operation on mains power during measurement

Refer to § 3.9.6, on page 8.

12. MAINTENANCE

12.1 Important recommendation

For maintenance, use only the specified spare parts. The maker cannot be held liable for an accident that occurs following a repair not done by its after-sale service department or by an approved repairer.

12.2 Recharging the battery

The battery charge is managed by the instrument when it is connected to AC mains via its mains power unit.

For safety and to ensure proper operation of the charger, the instrument must be off when the storage batteries are replaced.

Do not throw the storage batteries into a fire.

Do not expose the storage batteries to a temperature above 100°C.

Do not short-circuit the terminals of the storage batteries.

Note: the instrument keeps the date and time for one minute after removal of the battery.

12.3 Cleaning the housing

Use a soft cloth, dampened with soapy water. Rinse with a damp cloth and dry rapidly with a dry cloth or forced air. Do not use alcohol, solvents, or hydrocarbons.

12.4 Metrological check

Like all measuring or testing devices, the instrument must be checked regularly.

This instrument should be checked at least once a year. For checking and calibration, contact one of our accredited metrology laboratories (information and contact details available on request), at our Chauvin Arnoux subsidiary or the branch in your country.

12.5 Repair

For all repairs before or after expiry of warranty, please return the device to your distributor.

12.6 Upgrading the embedded software

The user can upgrade the embedded software of the C.A 8230 using the RS232 optical link cord

supplied with the instrument and a software upgrade available on Chauvin Arnoux's Web site (www.chauvin-arnoux.com). This makes it possible to update the software or add functions.

The embedded software can be upgraded only if the new version is compatible with the hardware version of the instrument, which is indicated in the *Information* sub-menu of the *Configuration* menu (see § 4.12, on page 14).

Attention: an update of the embedded software erases all data (configuration, alarms log, screen grabs, *Inrush* recordings, recording campaigns). Save the data you want to keep to a PC using the *DataViewer* software before upgrading the embedded software.

12.7 Sensors

Maintain and calibrate the current sensors as follows:

- Clean using a sponge moistened with soapy water and rinse in the same way with clear water, then dry rapidly.
- Keep the air gaps of the clips perfectly clean using a cloth. Oil the visible metallic parts lightly to prevent rust.
- Check the calibration every 2 years.

13. GENERAL CHARACTERISTICS

13.1 Housing

Housing:	elastomer protection.
Connectors:	two voltage input sockets. one special current connector (automatic recognition of the current sensor) one connector for the mains adapter. one connector for the optical serial link.
Keys:	function and navigation. Designed for ease of use with gloves on.
Prop:	to hold the instrument in a position 30° from the horizontal.
Cover:	for access to the storage batteries (back of the instrument).
Dimensions:	211 x 108 x 60mm.
Mass:	880 g (with storage batteries).

13.2 Power supplies

13.2.1 Mains power supply

Type:	external transformer unit (European or American), category III, 600 V RMS.
Range of use:	230V ± 10% @ 50Hz or 120V ± 10% @ 60Hz (depending on type of unit).
Max. power:	23.7 VA.

13.2.2 Battery power supply

For use of instrument without mains connection or to allow measurements to continue if mains power is cut off.

Battery:	6 NiMH rechargeable storage batteries in AA format (IEC LR6 – NEDA 15A).
Capacity:	at least 1,800 mAh.
Nominal voltage:	1.2V per storage battery, for a total of 7.2V.

Life:	at least 500 charging-discharging cycles.
Charging current:	between 0.6A and 0.8A.
Charging time:	approximately 4h 30 mn.
Service temp.	0°C to 50°C.
Recharging temp.:	10°C to 40°C.
Storage temp.:	storage ≤ 30 days, between -20°C and 50°C. storage from 30 to 90 days, between -20°C and 40°C. storage from 90 days to 1 year, between -20°C and 30°C.

13.2.3 Consumption

Standby mode, without display:	40 mA
With display brightness set to 50%:	200 mA

13.3 Conformity

13.3.1 Mechanical protection

According to IEC 61010-1, the C.A 8230 is regarded as a **PORTABLE (HAND-HELD) INSTRUMENT**.

- Operating position: any position.
- Reference position in operation: on a horizontal plane, standing on its prop or flat.
- Rigidity: as per IEC 61010-1.
- Fall: as per IEC 61010-1.
- Tightness: IP 54 as per IEC 60529 (IP2X electrical for the terminals).

13.3.2 Electromagnetic compatibility

Emissions and immunity in an industrial setting compliant with IEC 61326-1 without the external power supply by mains power unit.

13.3.3 User safety

- Application of safety rules as per IEC 61010-1 (isolation of voltage inputs and of the power supply earth by protecting impedances).
- Type of pollution: 2.
- Installation category III.

- Service voltage: 600 Vrms.
- Dual insulation (□) on I/Os with respect to earth.
- Dual insulation (□) between the voltage inputs, the power supply, and the other I/Os.
- For indoor use.

13.4 Environmental conditions

13.4.1 Climatic

The conditions of ambient temperature and relative humidity are as follows:

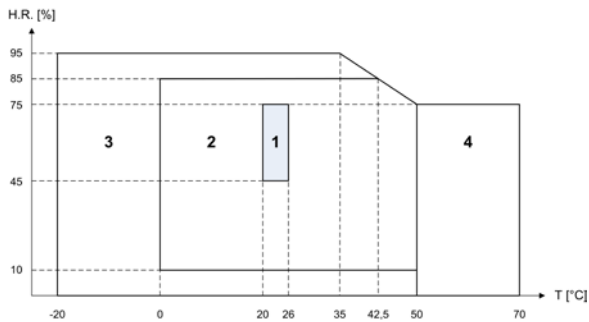

- 1 = Reference range
- 2 = Range of use
- 3 = Range of storage with storage batteries
- 4 = Range of storage without storage batteries

13.4.2 Altitude

Use: from 0 to 2,000 m.

Storage: from 0 to 10,000 m.

14. FUNCTIONAL CHARACTERISTICS

14.1 Reference conditions

Quantity of influence	Reference conditions
Ambient temperature:	23°C ± 3K.
Relative humidity:	from 45 to 75%.
Atmospheric pressure:	from 860 hPa to 1 060 hPa.
phase-to-earth voltage:	from 50 V _{RMS} to 600 V _{RMS} without DC (< 0.5%).
Input voltage of the standard current circuit:	from 30 mV _{RMS} to 1 V _{RMS} without DC (< 0.5%).
Input voltage of the Rogowski current circuit:	from 11.8 mV _{RMS} to 118 mV _{RMS} without DC (< 0.5%).
Network frequency:	50 Hz ± 0.1 Hz and 60 Hz ± 0.1 Hz.
Phase shift:	0° (active power) and 90° (reactive power).
Harmonics:	< 0.1%.
Balanced three-phase connection:	3φ mode OFF.

14.2 Electrical characteristics

14.2.1 Characteristics of the voltage input

Range of use:	from 0 V _{RMS} to 600 V _{RMS} AC+DC phase-neutral (*).
	from 0 V _{RMS} to 660 V _{RMS} AC+DC phase-phase (*).
	*: provided that the max. with 600 V _{RMS} respect to earth is not exceeded.
Input impedance:	451 kΩ.
Allowable overload:	1.2 x V _{nom} permanent. 2 x V _{nom} for one second.

14.2.2 Characteristics of the current input

Range of operation:	from 0 V to 1 V
Input impedance:	1 MΩ.
Allowable overload:	1,7 V.

The Amp**FLEX** configuration switches the current input to an integrating set-up ('Rogowski' chain) capable of interpreting the signals from sensors of the same name. The input impedance in this case is reduced to 12.4kΩ.

14.2.3 Pass band

Measurement channels:	256 points per period, or: <ul style="list-style-type: none"> ▪ At 50Hz: 6.4 kHz (256 × 50 ÷ 2). ▪ At 60Hz: 7.68 kHz (256 × 60 ÷ 2).
Analogue at -3dB:	> 10kHz.

14.2.4 Characteristics of the instrument alone

(without current sensor)

Attention: the 3φ mode is assumed to be deactivated (standard single-phase connection).

These data are for the case of the 'ideal current sensor' (perfect linearity and no phase shift). The characteristics in current (and derived quantities) are specified for each of the two configurations: without Amp**FLEX** and Amp**FLEX**.

Measurement		Measurement range		Display resolution	Max. error in reference range
		Minimum	Maximum		
Frequency		40Hz	69Hz	0,01Hz	±(1pt)
TRMS voltage		6V	600V ⁽⁶⁾	0,1V	±(0,5%+2pts)
DC voltage		6V	600V	0,1V	±(1%+5pts)
TRMS current	Without AmpFLEX	$I_{nom} \div 1000$ [A]	$1,2 \times I_{nom}$ [A]	0,1A $I < 1000A$	±(0,5%+2pts)
	AmpFLEX	10A	6500A	1A $I \geq 1000A$	±(0,5%+1pt)
DC current		1A	1700A ⁽¹⁾	0,1A $I < 1000A$ 1A $I \geq 1000A$	±(1%+1A)
Courant Peak	Without AmpFLEX	0A	$1,7 \times I_{nom}$ [A] ⁽²⁾	0,1A $I < 1000A$	±(1%+1A)
	AmpFLEX		9190A ⁽³⁾	1A $I \geq 1000A$	
Half-period TRMS current ⁽⁴⁾	Without AmpFLEX	$I_{nom} \div 100$ [A]	$1,2 \times I_{nom}$ [A]	0,1A $I < 1000A$ 1A $I \geq 1000A$	±(1%+5pts) ±(1%+1pt)
	AmpFLEX	100A	6500A	0,1A $I < 1000A$ 1A $I \geq 1000A$	±(1,5%+4A)
Peak voltage		6V	850V ⁽⁴⁾	0,1 V	±(1%+5pts)
Half-period TRMS voltage ⁽⁵⁾		6V	600V	0,1V	±(0,8%+5pts)
Peak factor		1	4	0,01	±(1%+2pts)
		4	9,99	0,01	±(5%+2pts)
Active power	Without AmpFLEX	0W	9999kW	4 digits	±(1%) Cos $\phi \geq 0.8$ ±(1,5%+10pts) 0,2 ≤ Cos $\phi < 0.8$
	AmpFLEX	0W	9999kW		4 digits
Reactive powers	Without AmpFLEX	0VAR	9999kVAR	4 digits	±(1%) Sin $\phi \geq 0.5$ ±(1,5%+10pts) 0,2 ≤ Sin $\phi < 0.5$
	AmpFLEX	0VAR	9999kVAR		4 digits
Apparent power		0	9999kVA	4 digits	±(1%)
Power factor		-1	1	0,001	±(1,5%) Cos $\phi \geq 0.5$
					±(1,5%+10pts) 0,2 ≤ Cos $\phi < 0.5$

(1) $1,2 \times 1000 \times \sqrt{2} = 1700A$

(2) $1,2 \times I_{nom} \times \sqrt{2} = 1,7 \times I_{nom}$

(3) $6500 \times \sqrt{2} = 9190A$

(4) $600 \times \sqrt{2} = 850V$

(5) **Attention:** The absolute value of the offset must not exceed 95% of the peak amplitude. In other words, $s(t) = S \times \sin(\omega t) + O$, so $|O| \leq 0.95 \times S$ (S positive). The 'half-period' values are the MAX and MIN values of the *waveforms* mode and the V_{RMS} and A_{RMS} values used in the *Alarm* mode and the *Inrush* mode.

(6) For the phase-to-earth voltage measurement (phase-neutral). For the phase-to-phase voltage measurement (phase-phase), in balanced three-phase mode, it is possible to reach 660 V RMS (balanced three-phase network having a phase-neutral voltage of 380 V RMS).

Measurement		Measurement range		Display resolution	Max. error in the reference range
		Minimum	Maximum		
Active energy	Without AmpFLEX	0Wh	9999MWh	4 digits	$\pm(1\%)$ $\text{Cos } \phi \geq 0.8$
					$\pm(1.5\%)$ $0.2 \leq \text{Cos } \phi < 0.8$
	AmpFLEX	0Wh	9999MWh	4 digits	$\pm(1\%)$ $\text{Cos } \phi \geq 0.8$
					$\pm(1.5\%)$ $0.5 \leq \text{Cos } \phi < 0.8$
Reactive energies	Without AmpFLEX	0VARh	9999MVARh	4 digits	$\pm(1\%)$ $\text{Sin } \phi \geq 0.5$
					$\pm(1.5\%)$ $0.2 \leq \text{Sin } \phi < 0.5$
	AmpFLEX	0VARh	9999MVARh	4 digits	$\pm(1.5\%)$ $\text{Sin } \phi \geq 0.5$
					$\pm(2.5\%)$ $0.2 \leq \text{Sin } \phi < 0.5$
Apparent energy		0VAh	9999MVAh	4 digits	$\pm(1\%)$
Phase shift		-179°	180°	1°	$\pm(2^\circ)$
Tangent $\text{VA} \geq 50\text{VA}$		-32.76	32.76	0.001 $\text{Tan } \phi < 10$	$\pm(1^\circ)$ on ϕ
				0.01	
				$\text{Tan } \phi \geq 10$	
Displacement factor (DPF)		-1	1	0.001	$\pm(1^\circ)$ on ϕ $\pm(5 \text{ pts})$ on DPF
Level of harmonics order $\in [1; 50]$ ($V_{\text{RMS}} > 50\text{V}$)		0%	999.9%	0,1%	$\pm(1\%+5\text{pts})$
Without AmpFLEX ($I_{\text{RMS}} > 3 \times I_{\text{nom}} \div 100$)					
AmpFLEX ($I_{\text{RMS}} > I_{\text{nom}} \div 10$)					
Angles of harmonics ($V_{\text{RMS}} > 50\text{V}$)		-179°	180°	1°	$\pm(3^\circ)$ order $\in [1; 25]$
Without AmpFLEX ($I_{\text{RMS}} > 3 \times I_{\text{nom}} \div 100$)					
AmpFLEX ($I_{\text{RMS}} > I_{\text{nom}} \div 10$)					
Global level of harmonics (THD-F) order ≤ 50		0%	999.9%	0.1%	$\pm(1\%+5\text{pts})$
Distortion factor (THD-R) order ≤ 50		0%	999.9%	0.1%	$\pm(1\%+10\text{pts})$
K factor		1	99.99	0.01	$\pm(5\%)$

Note: The stated uncertainties on the power and energy measurements are maximums for $\text{Cos}\phi=1$ and $\text{Sin}\phi =1$ and are typical values for the other phase shifts.

14.2.5 Characteristics of the current sensors

These characteristics are stated after linearisation. The errors of the sensors are compensated by a typical correction inside the instrument. This typical correction is in phase and in amplitude according to the type of sensor connected (detected automatically) and the gain of the current acquisition chain used.

The measurement error in RMS current and the phase error are additional errors (they must therefore be added to those of the instrument alone) stated as influences on the calculations performed by the analyser (powers, energies, power factors, tangent, etc.).

Type of sensor	TRMS current	Maximum error on I_{RMS}	Maximum error on ϕ
PAC93 clip 1000A	[1A; 10A[$\pm(1.5\%+1A)$	N.S.
	[10A; 100A[$\pm(2^\circ)$
	[100A; 800A[$\pm(3\%)$	$\pm(1.5^\circ)$
	[800A; 1200A[$\pm(5\%)$	
	[1200A; 1400A] ⁽¹⁾		
1000A C193 clip	[1A; 3A[$\pm(0.8\%)$	N.S.
	[3A; 10A[$\pm(1^\circ)$
	[10A; 100A[$\pm(0.3\%)$	$\pm(0,5^\circ)$
	[100A; 1200A]	$\pm(0.2\%)$	$\pm(0,3^\circ)$
AmpFLEX A193 3000A	[10A; 100A[$\pm(3\%)$	$\pm(1^\circ)$
	[100A; 6500A]	$\pm(2\%)$	$\pm(0.5^\circ)$
200A MN93 clip	[0,5A; 2A[$\pm(3\%+1A)$	N.S.
	[2A; 10A[$\pm(6^\circ)$
	[10A; 100A[$\pm(2.5\%+1A)$	$\pm(3^\circ)$
	[100A; 240A]	$\pm(1\%+1A)$	$\pm(2^\circ)$
100A MN93A clip	[100mA; 300mA[$\pm(0.7\%+2mA)$	N.S.
	[300mA; 1A[$\pm(1.5^\circ)$
	[1A; 120A]	$\pm(0.7\%)$	$\pm(0.7^\circ)$
5A MN93A clip	[5mA; 50mA[$\pm(1\%+0.1mA)$	$\pm(1.7^\circ)$
	[50mA; 500mA[$\pm(1\%)$	$\pm(1^\circ)$
	[500mA; 6A]	$\pm(0.7\%)$	
E3N 100A clip Sensibility 10 mV/A	[0 A ; 40A[$\pm(2\% + 50 mA)$	$\pm(0.5^\circ)$
	[40 A ; 100 A[$\pm(5\%)$	
E3N 10A clip Sensibility 100 mV/A	[0 A ; 10A]	$\pm(1.5\% + 50 mA)$	$\pm(1^\circ)$
5A Adapter	[5mA; 50mA[$\pm(1\%)$	$\pm(1^\circ)$
	[50mA; 6A]	$\pm(0.5\%)$	$\pm(0^\circ)$

(1)DC only. N.S.: Not Specified.

15. APPENDICES

This chapter gives the mathematical formulas used by the C.A 8230 to calculate the various parameters.

15.1 Mathematical formulas

15.1.1 Network frequency

The sampling is locked to the network frequency so as to provide 256 samples per period (NECHPER) from 40 Hz to 70Hz. This locking is essential for the calculations of the reactive powers, the calculations of levels and angles, and the calculations giving the harmonic magnitudes.

Sampling of the appliance on the network frequency observed is performed by default with the voltage channel. However, if the voltage is insufficient or indeed absent, this sampling process is carried out with the current channel. The appliance can therefore be used without voltage with a current only.

15.1.2 Half-period RMS value voltage and current

Half-period RMS voltage

$$V_{dem} = \sqrt{\frac{1}{NechLobe} \cdot \sum_{n:Zéro}^{Zéro\ suivant} V[n]^2}$$

Half-period RMS current

$$A_{dem} = \sqrt{\frac{1}{NechLobe} \cdot \sum_{n:Zéro}^{Zéro\ suivant} A[n]^2}$$

Remark: These values are calculated for each half-period so as not to miss any fault. 'NechLobe' is half of NECHPER for a pure sinusoidal signal with no offset.

15.1.3 Minimum-maximum RMS voltage and current (min-max)

$$V_{max} = \max(V_{dem}), \quad V_{min} = \min(V_{dem})$$

$$A_{max} = \max(A_{dem}), \quad A_{min} = \min(A_{dem})$$

15.1.4 Short-term flicker (PST) of the voltage:

Numerical method derived from standard IEC 61000-4-15.

The PST value is refreshed every 10 minutes.

15.1.5 Peak voltage and current:

$$V_{pp} = \max(V[n]), \quad V_{pm} = \min(V[n]) \quad n \in [0..NECHPER - 1]$$

$$A_{pp} = \max(A[n]), \quad A_{pm} = \min(A[n]) \quad n \in [0..NECHPER - 1]$$

Note: calculations every second on the curve in progress.

15.1.6 Peak factor of the current and voltage

Peak factor of voltage

$$V_{cf} = \frac{V_{pp} - V_{pm}}{2 \cdot \sqrt{\frac{1}{NECHPER} \cdot \sum_{n=0}^{NECHPER-1} V[n]^2}}$$

Peak factor of current

$$A_{cf} = \frac{A_{pp} - A_{pm}}{2 \cdot \sqrt{\frac{1}{NECHPER} \cdot \sum_{n=0}^{NECHPER-1} A[n]^2}}$$

Note: calculations every second on the curve in progress.

15.1.7 1s RMS voltage and current:

$$V_{rms} = \sqrt{\frac{1}{NechSec} \cdot \sum_{n=0}^{NechSec-1} V[n]^2} \quad \text{Tension efficace}$$

$$A_{rms} = \sqrt{\frac{1}{NechSec} \cdot \sum_{n=0}^{NechSec-1} A[n]^2} \quad \text{Courant efficace}$$

NechSec: number of samples in second of calculation.

15.1.8 Harmonic calculations

These are done by 1024-point FFT (4 periods) without windowing (cf. IEC 61000-4-7). From the real and imaginary parts, the levels V_{harm} and A_{harm} are calculated (with respect to the RMS value of the fundamental) and the angles V_{ph} and A_{ph} are calculated (phase shift with respect to the fundamental).

$$V_{thd} = \frac{\sqrt{\sum_{n=2}^{50} V_{harm}[n]^2}}{V_{harm}[1]}, \quad A_{thd} = \frac{\sqrt{\sum_{n=2}^{50} A_{harm}[n]^2}}{A_{harm}[1]}$$

The voltage harmonic level (V_{harm}) is multiplied by the current harmonic level (A_{harm}) to calculate the apparent power harmonic level (V_{Aharm}). The power harmonic angles are calculated from the difference between voltage harmonic angles and the current harmonic angles.

15.1.9 K factor of the current

K factor (KF)

$$Akf = \frac{\sum_{n=1}^{n=50} n^2 \cdot Aharm[n]^2}{\sum_{n=1}^{n=50} Aharm[n]^2}$$

15.1.10 Various 1s powers in single-phase connection

Active power

$$W = \frac{1}{NechSec} \sum_{n=0}^{NechSec-1} V[n] \cdot A[n]$$

Apparent power

$$VA = V_{rms} \cdot A_{rms}$$

Two calculation possibilities for the reactive power (VAR):

Reactive power **WITHOUT** harmonics

$$VAR = \frac{1}{NechSec} \sum_{n=0}^{NechSec-1} VF[n-NECHPER/4] \cdot AF[n]$$

Reactive power **WITH** harmonics

$$VAR = \sqrt{VA^2 - W^2}$$

The reactive power is calculated either on the filtered signal (without harmonics), as EDF requires, or from the apparent and active energies (signal with harmonics).

15.1.11 Various 1s total powers in balanced three-phase connection

Total active power

$$W = \frac{-3}{\sqrt{3} \times NechSec} \sum_{n=0}^{NechSec-1} U[n-NECHPER/4] \cdot A[n]$$

Total apparent power

$$VA = \frac{3}{\sqrt{3}} \cdot U_{RMS} \cdot A_{RMS}$$

Total reactive power **WITH** harmonics

$$VAR = \sqrt{VA^2 - W^2}$$

Total reactive power **WITHOUT** harmonics

$$VAR = \frac{3}{\sqrt{3} \times NechSec} \sum_{n=0}^{NechSec-1} UF[n] \cdot AF[n]$$

Note: U = phase-to-phase voltage between phases 1 and 2 (V_1-V_2), A = phase-to-earth current of phase 3

15.1.12 Various levels

Power factor

$$PF = \frac{W}{VA}$$

Displacement factor

$$DPF = \cos(\phi)$$

Cosine of the angle between the voltage fundamental and the current fundamental

$$\cos(\phi) = \frac{\sum_{n=0}^{NechSec-1} VF[n] \cdot AF[n]}{\sqrt{\sum_{n=0}^{NechSec-1} VF[n]^2} \cdot \sqrt{\sum_{n=0}^{NechSec-1} AF[n]^2}}$$

15.1.13 Various energies (total energies in the case of the balanced three-phase connection)

Eight different energy meters can be distinguished.

Active energy consumed

$$Whc = \sum_{Tint} \frac{W}{3600} \text{ pour } W \geq 0$$

Active energy generated

$$Whg = \sum_{Tint} \frac{-W}{3600} \text{ pour } W < 0$$

Apparent energy consumed

$$VAhc = \sum_{Tint} \frac{VA}{3600} \text{ pour } W \geq 0$$

Apparent energy generated

$$VAhg = \sum_{Tint} \frac{VA}{3600} \text{ pour } W < 0$$

Inductive reactive energy consumed

$$VARhLc = \sum_{Tint} \frac{VAR}{3600} \text{ pour } VAR \geq 0 \text{ et } W \geq 0$$

Capacitive reactive energy consumed

$$VARhCc = \sum_{Tint} \frac{-VAR}{3600} \text{ pour } VAR < 0 \text{ et } W \geq 0$$

Capacitive reactive energy generated

$$VARhCg = \sum_{Tint} \frac{VAR}{3600} \text{ pour } VAR \geq 0 \text{ et } W < 0$$

Inductive reactive energy generated

$$VARhLg = \sum_{Tint} \frac{-VAR}{3600} \text{ pour } VAR < 0 \text{ et } W < 0$$

15.2 Hysteresis

Hysteresis is a filtering principle often used after a threshold detection stage, in the Alarm mode  (§ 4.10, page 13). A correctly adjusted hysteresis avoids repeated changes of status when the measurement oscillates about the threshold.

15.2.1 Detection of voltage overload

With a hysteresis of 2%, for example, the return level for voltage overload detection will be (100% - 2%) or 98% of the reference voltage threshold.

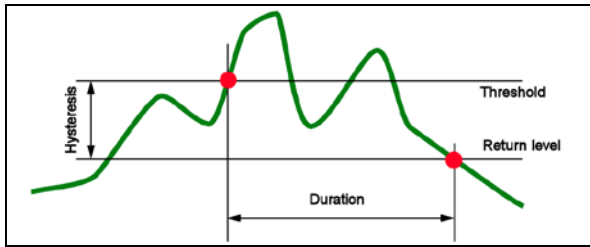

Figure 71: Hysteresis for voltage overload detection. .008

15.2.2 Undervoltage or blackout detection

With a hysteresis of 2%, for example, the return level for undervoltage detection will be (100% + 2%) or 102% of threshold voltage U_{ref} .

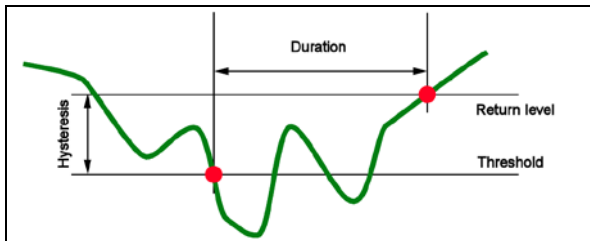

Figure 72: Hysteresis for undervoltage detection. .009

15.3 Minimum scale values displayed in the Waveforms mode

- For all types of current sensor

$$A_{RMS} \leq [\text{minimum current displayed}]$$

$$\Rightarrow A_{RMS} = 0$$

-

With the MN93A clip (5A rating) and the 5A adapter

$$[\text{minimum current displayed}] \leq 0.2$$

$$\Rightarrow [\text{minimum current displayed}] = 0.2$$

$$[\text{minimum scale value in current}] \leq 1$$

$$\Rightarrow [\text{minimum scale value in current}] = 1$$

The minimum voltage value displayed is 5 V

$$V_{RMS} \leq 5 \text{ V} \Rightarrow V_{RMS} = 0 \text{ V}$$

15.4 4-quadrants diagram

This diagram is used for power and energy measurements **W** (Chapter 4.10, page 19).

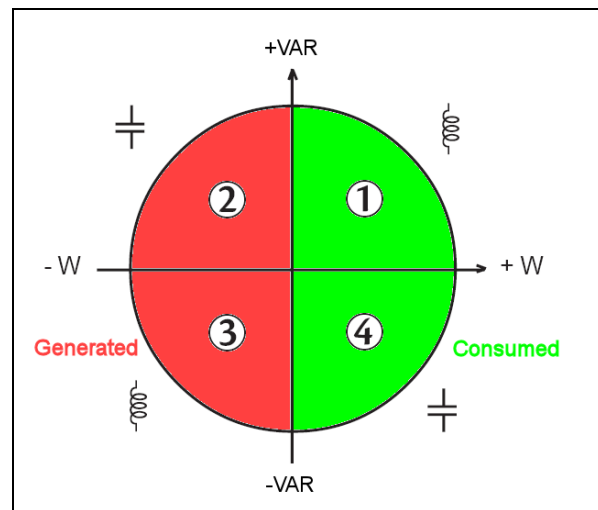

Figure 73: Representation of the four power quadrants. .010

Table of minimum scale values and minimum values displayed in the Waveforms mode.

Type current sensor	Minimum current displayed (A)	Minimum scale value in current (A)
Amp FLEX 3,000 A	9	60
PAC clip, 1,000 A	1	10
C clip, 1,000 A	0.5	10
MN93 clip, 200 A	0.5	2
MN93A clip, 100 A	0.2	1
MN93A clip, 5 A	(Primary x 5) / (Secondary x 1,000)	(Primary x 5 x 10) / (Secondary x 1,000)
E3N clip, 100 A	0.2	1
E3N clip, 10A	0.2	1
5 A adapter	(Primary x 5) / (Secondary x 1,000)	(Primary x 5 x 10) / (Secondary x 1,000)