

EARTH AND RESISTIVITY TESTER

C.A 6471

User's manual



Thank you for purchasing a **C.A 6471 earth and resistivity tester**. To obtain the best service from your unit:

- **read** these operating instructions carefully,
- **comply** with the precautions for use.

 **WARNING**, risk of **DANGER!** The operator must refer to these instructions whenever this danger symbol appears.

 Equipment protected by double insulation.

 Earth terminal.

 CE marking indicates conformity with European directives, in particular LVD and EMC.

 The rubbish bin with a line through it indicates that, in the European Union, the product must undergo selective disposal in compliance with Directive WEEE 2002/96/EC. This equipment must not be treated as household waste.

Definition of measurement categories:

- Measurement category IV corresponds to measurements taken at the source of low-voltage installations.
Example: power feeders, counters and protection devices.
- Measurement category III corresponds to measurements on building installations.
Example: distribution panel, circuit-breakers, machines or fixed industrial devices.
- Measurement category II corresponds to measurements taken on circuits directly connected to low-voltage installations.
Example: power supply to electro-domestic devices and portable tools.

PRECAUTIONS FOR USE

This instrument is protected from accidental voltages of not more than 50 V with respect to earth in measurement category IV. The guaranteed level of protection of this equipment may be compromised if used in a manner not specified by the manufacturer.

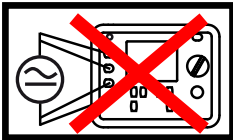

- Make no measurements on conductors likely to be connected to the network or to earth conductors that are not disconnected.
- Do not exceed the maximum rated voltage and current and the measurement category.
- Never exceed the protection limits indicated in the specifications.
- Comply with the conditions of use, namely the temperature, the humidity, the altitude, the degree of pollution, and the place of use.

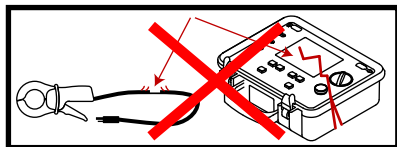

- Do not use the device or its accessories if they seem damaged.
- Use only the charging unit supplied with the tester to recharge the internal battery.
- Use connection accessories of which the overvoltage category and service voltage are greater than or equal to those of the measuring device (50V CAT IV). Use only accessories that comply with safety standards (IEC 61010-2-031 and 32).



- Troubleshooting and metrological checks must be done only by accredited skilled personnel.
- Wear the appropriate protective gear (insulating boots and gloves).

Foreword:

The potentials on the various rods used for an earth measurement may be different if a nearby electrical installation is defective or certain weather conditions prevail (thunderstorms). It is up to the operator to decide whether to continue or postpone a campaign of measurements in a given situation.

CONTENTS

1. START-UP	4
1.1. Unpacking.....	4
1.2. Characteristics label.....	4
1.3. Charging the battery	5
2. PRESENTATION OF THE DEVICE	6
2.1. Functions of the device	7
2.2. Keypad.....	7
2.3. Display unit	8
2.4. Operating principle.....	9
3. AUTOMATIC MODE	10
3.1. Resistance measurement.....	10
3.2. 3P earth measurement	13
3.3. 4P earth measurement	15
3.4. Measurement of soil resistivity ρ	18
3.5. Earth measurements with 2 clamps	22
4. ERROR REPORTING	23
4.1. Electrode resistance too high	23
4.2. Out of range	23
4.3. Misconnection	23
4.4. Indicators of limits of use.....	23
5. MEASUREMENTS IN MANUAL MODE	25
5.1. Choice of measurement frequency	25
5.2. Switching of the measurement voltage	25
5.3. Manual settings for the resistance measurement	26
5.4. Manual settings for the 3P earth measurement	26
5.5. Manual settings for the 4P earth measurement.....	27
5.6. Manual settings for the soil resistivity measurement	28
5.7. Manual settings for the measurement with 2 clamps.....	28
5.8. Smoothing.....	28
6. MEMORY FUNCTION	29
6.1. Storage of measurement results.....	29
6.2. Retrieval of stored results	30
6.3. Erasure of the memory	31
7. CONFIGURATION (SETUP)	33
7.1. Press the CONFIG key	33
7.2. Press the DISPLAY key	33
7.3. Press the MEM key.....	34
7.4. Press the <i>MR</i> key	34
7.5. Internal parameters	34
7.6. Check of the display unit	34
8. ERROR MESSAGES	35
9. CONNECTION TO A PC AND ANALYSIS SOFTWARE	36
10. SPECIFICATIONS AND TECHNICAL CHARACTERISTICS	37
10.1. Reference conditions	37
10.2. Electrical characteristics.....	37
10.3. Power supply	42
10.4. Environmental conditions	43
10.5. Characteristics of construction	43
10.6. Conformity to international standards.....	43
10.7. Electromagnetic compatibility	43
11. TERMS AND DEFINITIONS	44
12. GLOSSARY	45
13. MAINTENANCE	46
13.1. Cleaning	46
13.2. Replacement of the fuse	46
13.3. Replacing the battery	47
13.4. Metrological check	48
13.5. Repair.....	48
14. WARRANTY, SERVICE	49
15. TO ORDER	50
15.1. Accessories	50
15.2. Replacement parts	51

1. START-UP

1.1. UNPACKING

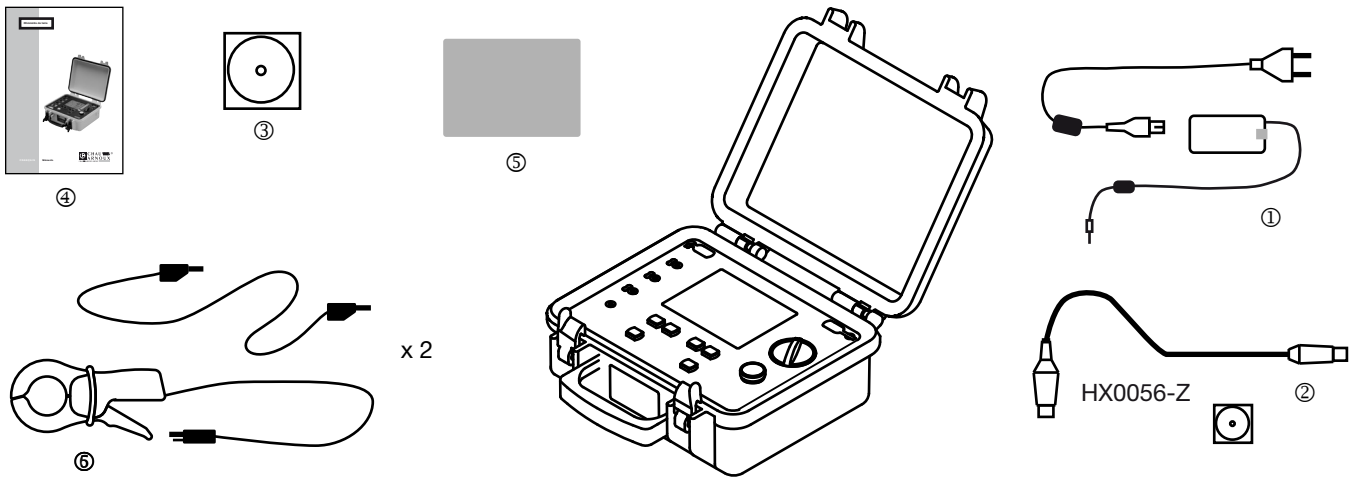

- ① One line power adapter + 2-pole cable to recharge the battery.
- ② Data export software + an optical/USB communication cord.
- ③ User manual on CD-ROM (1 per language).
- ④ Simplified user manuals (1 per language).
- ⑤ Characteristics labels (1 per language).
- ⑥ 2 C182 clamps with 2 safety leads.

1.2. CHARACTERISTICS LABEL

Affix the appropriate characteristics label to the inside of the cover of the device (labels in five different languages are provided).

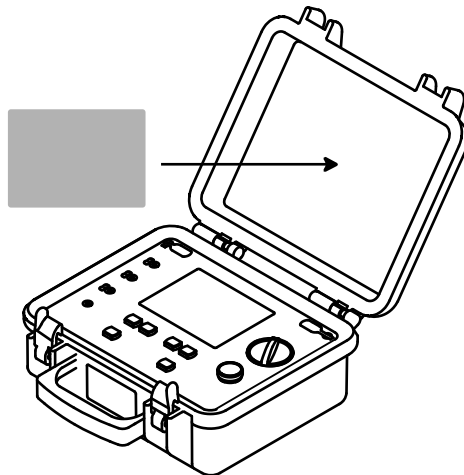

1.3. CHARGING THE BATTERY

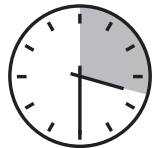
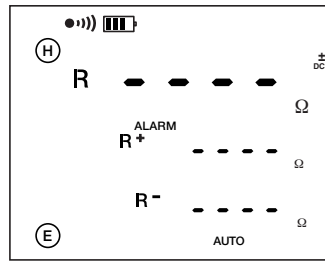
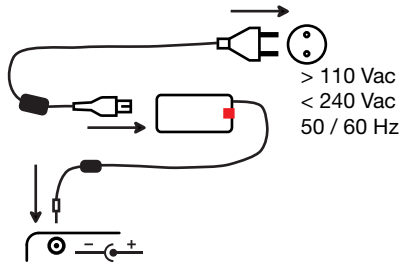

Charging time: 3h30'

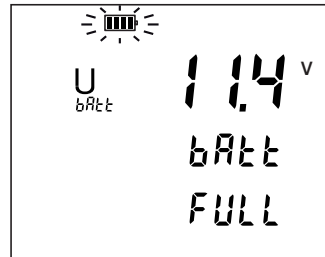

Start by fully charging the battery before the first use. The charging must be done between 0 and 40°C.

After prolonged storage, the battery may be fully discharged. In this case, the first charge may last several hours. To enable the battery to recover its initial capacity, we recommend performing several successive complete charging/discharging cycles (3 to 5 cycles).

For a discharging cycle, set the switch to mΩ.

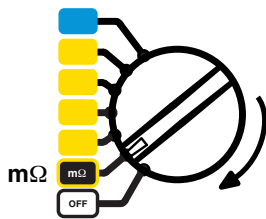

Short-circuit by connecting a lead between terminals H and E.

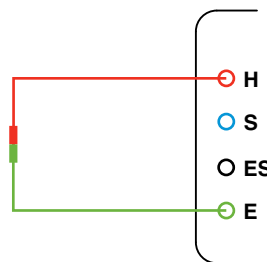

Switch the device to manual mode. Press the CONFIG key, then the  key, then the CONFIG key 3 times.

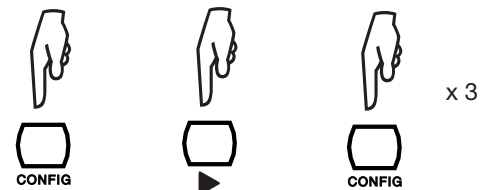

Start the measurement by pressing the START/STOP button.

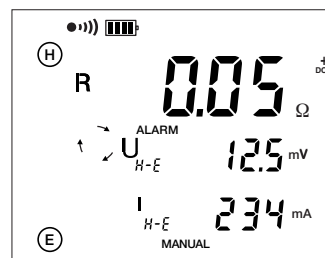

Let the measurement continue until the battery is fully discharged.

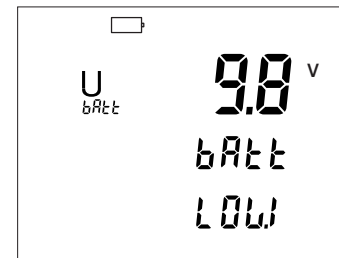

2. PRESENTATION OF THE DEVICE

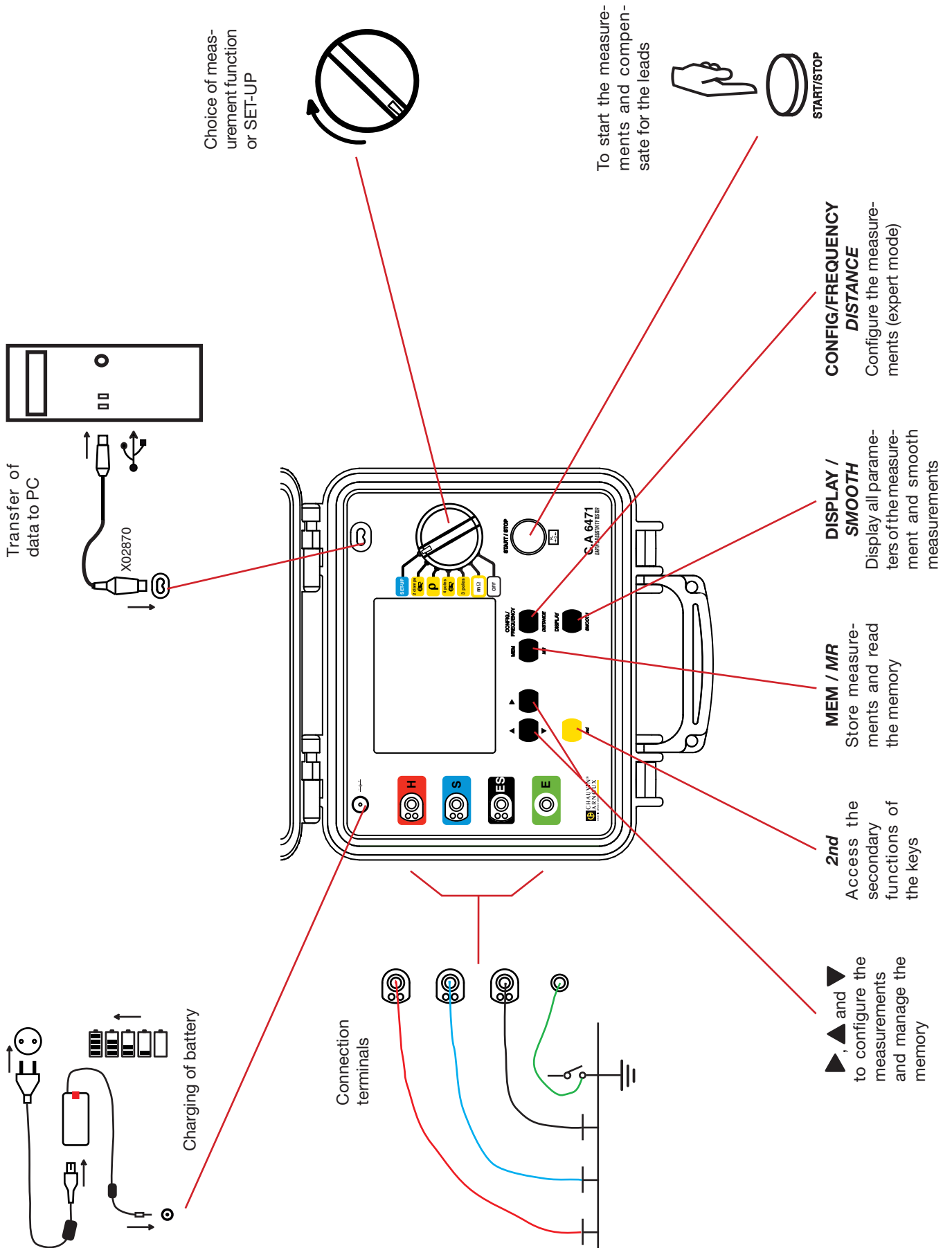

2.1. FUNCTIONS OF THE DEVICE

The C.A 6471 earth tester is a complete portable measuring device intended for earth measurements and soil resistivity measurements. It is contained in a housing suitable for field use and supplied by a rechargeable battery with built-in charger.

Measurement functions	: resistance, 2-wire or 4-wire, earth resistance, 3-point or 4-point coupling of earth resistances selective earth resistance soil resistivity earth resistance with 2 clamps
Control	: 7-position switch, 6-key pad, and a START/STOP button
Display	: back-lit 108 x 84mm LCD display unit having 3 simultaneous numerical display levels

2.2. KEYPAD

When the buzzer is active (●) symbol displayed), the device confirms each key press by an audible beep. A higher-pitched beep means that the key press is disabled or has no effect.

A long press (more than 2 seconds) is confirmed by a second audible beep.

The functions of the keys are described briefly opposite.

Special case:

To increase a flashing figure or number, press the ▲ key.

To decrease a flashing figure or number, press 2nd and ▲. The 2nd symbol remains displayed to indicate that the 2nd key is still active and does not have to be pressed each time and that the ▼ key is directly accessible. To reverse the direction, press the 2nd key again.

To change an item or a frequency, press the ► key.

2.3. DISPLAY UNIT

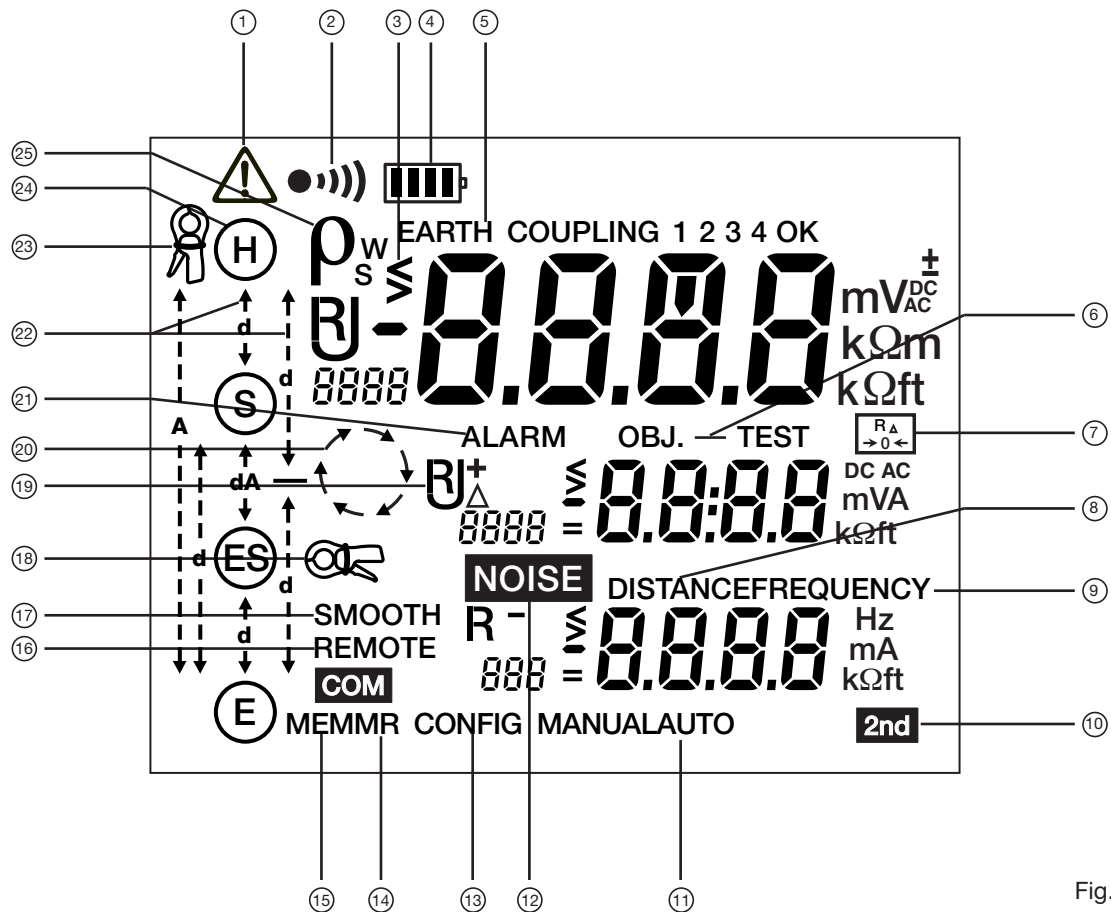



Fig. 1

- ① DANGER symbol.
- ② Audible tone On.
- ③ A flashing «>>» or «<<» indicates a value that is out of bounds.
- ④ Indicates the battery charge condition.
- ⑤ Indicates whether the 3-pole EARTH measurement or the EARTH COUPLING measurement has been selected.
- ⑥ Object (OBJ) and TEST no. for the storage of results.
- ⑦ Lead compensation for 2-wire measurements is active.
- ⑧ The DISTANCE function used to enter distances is active.
- ⑨ The FREQUENCY function for manual frequency changes during a measurement is active.
- ⑩ The 2nd key has been pressed.
- ⑪ The MANUAL or AUTO mode is active.
- ⑫ NOISE interfering with the measurement has been detected.
- ⑬ The CONFIG mode, allowing modification of the measurement parameters, is active.
- ⑭ The MR mode, for the display of stored results, is active.
- ⑮ The MEM mode (storage of results) is active.
- ⑯ Indicates that the device is remote-controlled by a computer (REMOTE).
- ⑰ SMOOTHing of the measurement results is active.
- ⑱ Indicates that a clamp must be connected to terminal ES (flashing) or is connected to it (steady).

- ⑲ Display of the measured parameter (R, U, I).
- ⑳ Rotating arrows indicate that a measurement is in progress.
- ㉑ Indicates that the ALARM function is active.
- ㉒ Indicates the distances d or/and A.
- ㉓ Indicates that a clamp must be connected to terminal H (flashing) or is connected to it (steady).
- ㉔ Indicates which of terminals H, S, ES, and E are to be connected according to the measurement function chosen (fixed) or are missing (flashing).
- ㉕ Display of soil resistivity ρ measured by the Wenner or Schlumberger method (ρ_w or ρ_s).

In this user manual, the symbol  indicates flashing.

2.4. OPERATING PRINCIPLE

The device has 2 operating modes:

- Automatic mode for routine applications,
- Manual/Expert mode in which the user can change the parameters of the measurement functions.

2.4.1. AUTOMATIC MODE

- Set the switch to the desired function,
- Make the connections appropriate to the function,
- Press the START button. The device makes the measurement and stops automatically.
- Read the measurement result on the display unit and the relevant parameters using the DISPLAY key. You can record all of this information in the internal memory of the device.

2.4.2. MANUAL OR EXPERT MODE

- Set the switch to the desired function,
- Make the connections appropriate to the function,
- Select "MANUAL" mode.
- Choose the various measurement parameters using the CONFIG key.
- Press the START button. The measurement frequency or the direction of the current (resistance measurement) can be changed during the measurement to view their impact upon the measurement and the parameters relevant to the measurement can be viewed using the DISPLAY key.
- When the measurement results are acceptable, stop the measurement by pressing the STOP button.
- View the result on the display and toggle through the relevant parameters using the DISPLAY key. You can save all of this information to the internal memory of the device.

3. AUTOMATIC MODE

3.1. RESISTANCE MEASUREMENT

3.1.1. 2-WIRE MEASUREMENT

Set the switch to mΩ.

Connect the resistance to be measured between terminals H and E. It must not be live.

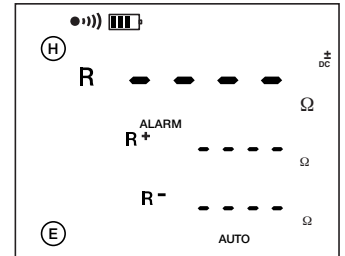
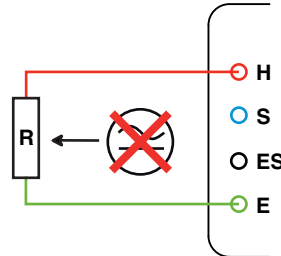
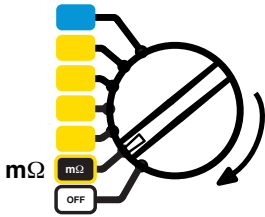

Start the measurement by pressing the START/STOP button.

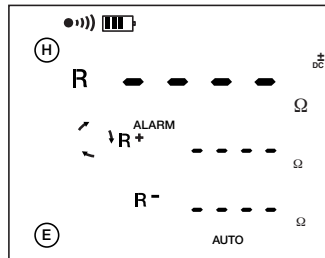

The device makes a measurement with a positive current (R+), then reverses the direction of the current and makes another measurement (R-).

$$R = \frac{(R+) + (R-)}{2}$$

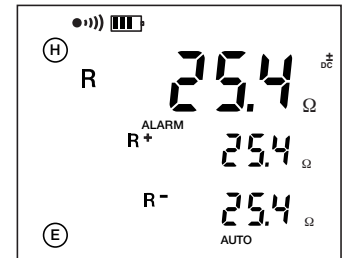

To display the measurement parameters, press the DISPLAY key several times.

The device displays the following quantities (see the glossary, §12):

R+, R-, +U_{H-E}, +I_{H-E}, -U_{H-E}, -I_{H-E}, U-Act (U_{H-E} and its frequency), and R_{Δ0} if there is compensation for the measurement leads.

3.1.2. COMPENSATION FOR THE MEASUREMENT LEADS

Lead compensation subtracts the resistance of the test leads from the measured result.

Short-circuit the measurement leads.

Start the measurement by pressing the 2nd key, then the START/STOP button.

This value will be deducted from all resistance values measured thereafter.

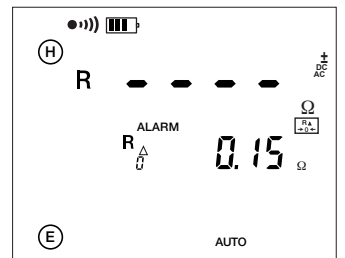
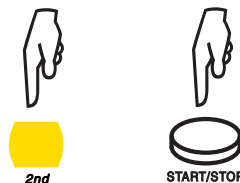
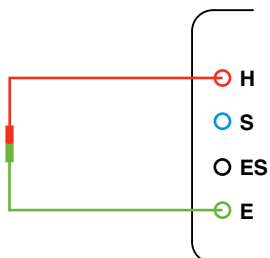

Lead compensation is lost when the select switch is turned to another function.

3.1.3. ALARM FUNCTION

This function exists only for the 2-wire resistance measurement. By default, the visual alarm (the ALARM symbol flashes) and the audible alarm (the buzzer sounds for a few seconds) are triggered when $R < 2\Omega$. This threshold can be changed using the SET-

UP function.

Set the switch to SET-UP.

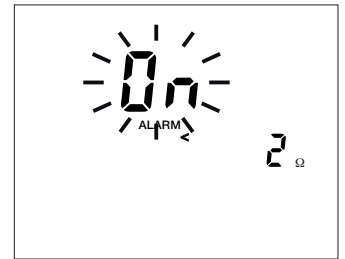
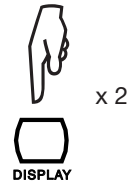
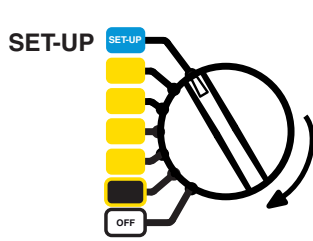

To turn the alarm On or OFF.



To access the direction of the alarm.



To choose a low (<) or high (>) alarm.

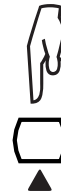

To set the value of the alarm between 1 and 999 Ω .

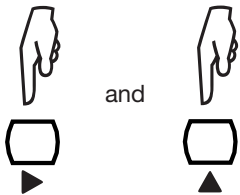

To complete the adjustment of the alarm.

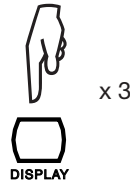

3.1.4. 4-WIRE MEASUREMENT

This measurement is used to improve the resolution (10x better than the 2-wire measurement) for weak resistance values; no compensation for the measurement leads is needed.

The device must first be configured for the 4-wire measurement.

Press the CONFIG key

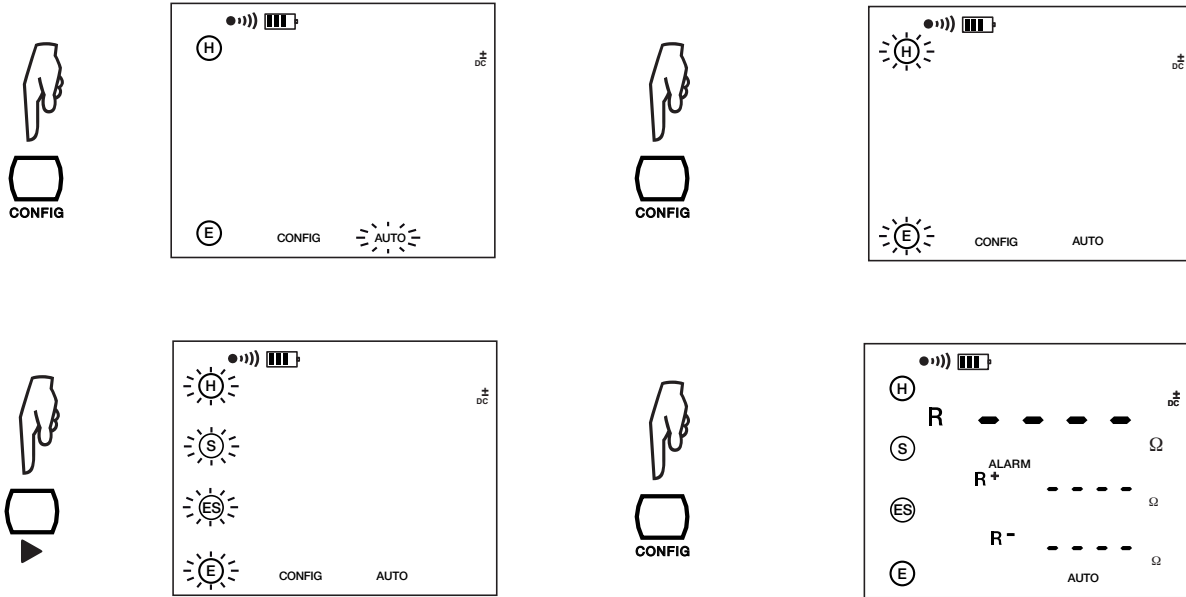

To return to 2-wire measurement, simply repeat this procedure.

Connect the resistance to be measured in 4-wire mode. It must not be live.

Start the measurement by pressing the START/STOP button.

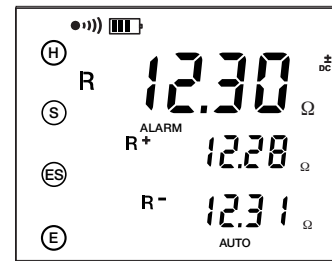
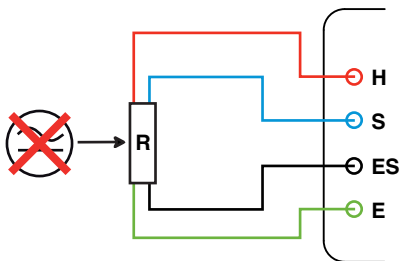

To display the measurement parameters, press the DISPLAY key several times.

The device displays the following quantities (see the glossary, §12):
 R^+ , R^- , $+U_{S-ES}$, $+I_{H-E}$, $-U_{S-ES}$, $-I_{H-E}$, U-Act (U_{S-ES} and its frequency, U_{H-E} and its frequency).

3.2. 3P EARTH MEASUREMENT

This function is used to measure an earth resistance with 2 auxiliary electrodes.

There are several measurement methods. We recommend the “62%” method.

Set the switch to “3 poles”.

Plant electrodes H and S to form a straight line with the earth electrode. The distance between electrode S and the earth electrode is 62% of the distance between electrode H and the earth electrode; the distance between the electrodes H and S should be at least 30m.

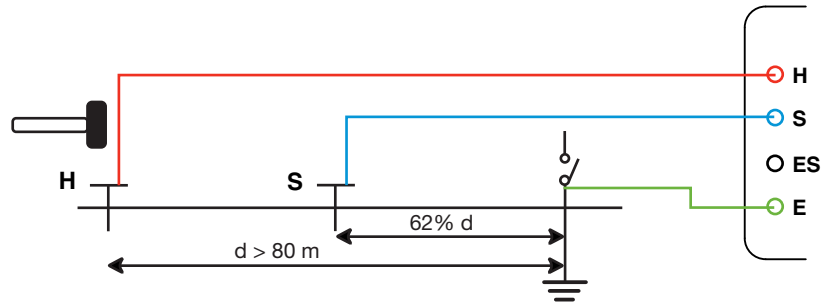
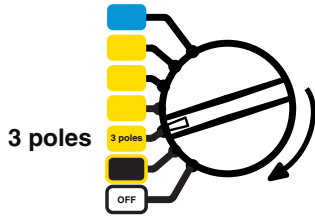

In order to avoid electromagnetic interference, it is best to unwind the full length of each cable from the reel, to keep the cables as far apart as possible on the ground, taking care not to form loops, and to avoid placing the cables near or parallel to metallic conductors (cables, rails, fences, etc.). Connect the cables to terminals H and S; disconnect the earth strap, then connect terminal E to the earth electrode to be tested.

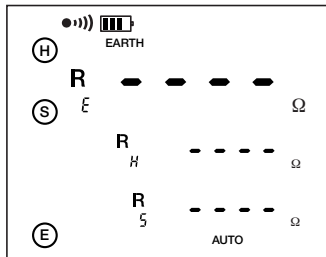

Start the measurement by pressing the START/STOP button.

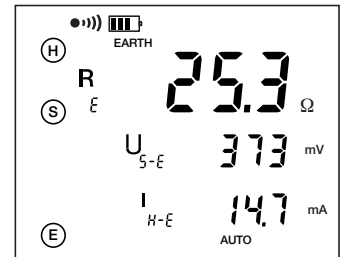

To display the measurement parameters, press the DISPLAY key several times.

The device displays the following quantities (see the glossary, §12):

R_E , U_{S-E} , I_{H-E} , U-Act (U_{H-E} and its frequency, U_{S-E} and its frequency).
Plus R_H , R_S if the measurement was started by a long press of START/STOP.

To measure the resistances of electrodes H and S, or if the resistance of the electrodes is too large (see §4), start the measurement with a **long press** of the START/STOP button.

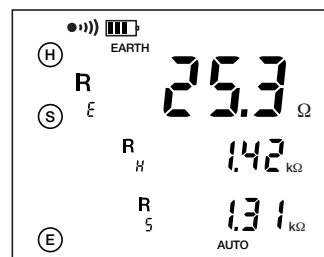
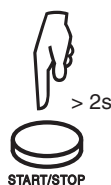

3.2.1 RECOMMENDATIONS FOR A RELIABLE MEASUREMENT

■ Moving the auxiliary electrodes

Move electrode S towards electrode H by a distance equal to 10% of d and make another measurement. Then move electrode S again by a distance equal to 10% of d , but towards the earth electrode.

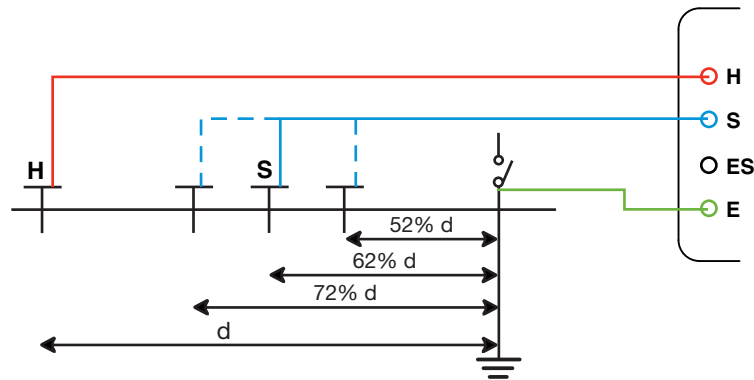

The 3 measurement results should be the same to within a few percent. If this is the case, the measurement is valid. If not, electrode S is in the zone of influence of the earth electrode. It will be necessary to increase distance d and repeat the measurements.

■ Positioning of the auxiliary electrodes

To make sure that your earth measurements are not distorted by interference, we recommend repeating the measurement with the auxiliary electrodes placed at a different distance and in another direction (for example rotated 90° from the first alignment).



If you find the same values, your measurement is reliable. If the measured values are substantially different, it is likely that they were influenced by earth currents or a groundwater course. It may be useful to drive the electrodes deeper and/or wet the ground near them to reduce their contact resistance with the soil.

Avoid routing the connecting cables of the earth electrodes near or parallel to other cables (transmission or supply), metallic conductors, rails, or fences: high test frequencies may cause cross-talk and affect the measurements.

3.3. 4P EARTH MEASUREMENT

3.3.1. MEASUREMENT WITHOUT CLAMP

This function is suited to the measurement of very low earth resistances. It provides better resolution (10x better than 3P measurement) and there is no need to compensate for the resistance of the measurement leads.

Set the switch to "4 poles".

Place electrodes H and S at least 30m apart.

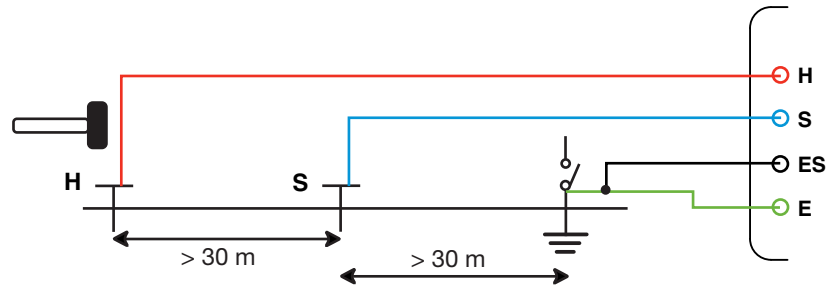
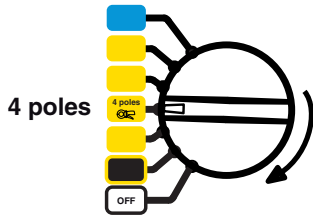

In order to avoid electromagnetic interference, it is best to unwind the full length of each cable from the reel, to keep the cables as far apart as possible on the ground, taking care not to form loops, and to avoid placing the cables near or parallel to metallic conductors (cables, rails, fences, etc.). Connect the cables to terminals H and S; disconnect the earth strap, then connect terminals E and ES to the earth electrode to be tested.

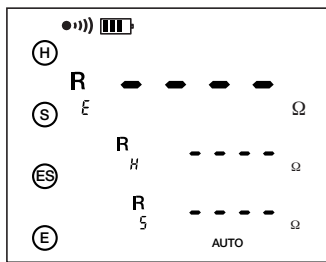

Start the measurement by pressing the START/STOP button.

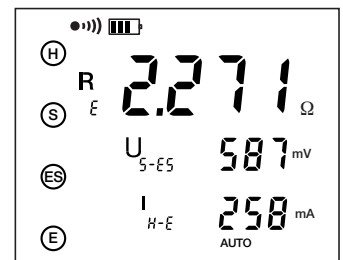

To display the measurement parameters, press the DISPLAY key several times.

The device displays the following quantities (see the glossary, §12):

R_E , U_{S-E} , I_{H-E} , U-Act (U_{H-E} and its frequency, U_{S-E} and its frequency).

Plus R_H , R_S , U_{H-E} if the measurement was started by a long press of START/STOP.

To measure the resistances of electrodes H and S, or if the resistance of the electrodes is too large (see §4), start the measurement with a **long press** of the START/STOP button.

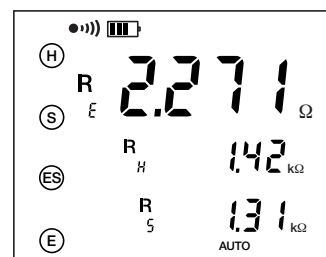

We recommend repeating the measurement with the auxiliary electrodes placed at a different distance and in another direction (see §3.2.1).

3.3.2. MEASUREMENT WITH CLAMP (SELECTIVE EARTH)

For this selective earth measurement you need a current clamp, either a C182 (supplied with the device) or an MN82 (available as an accessory). The C182 clamp is more precise, suited to the measurement of higher currents (up to 40 Arms) and to being placed on thicker conductors, while the MN82 clamp, which is easier to handle, accepts currents only up to 10 Arms and can be placed on conductors only up to 20mm in diameter. Use only these two types of current clamp, which are specially designed to work with the C.A 6471 earth and resistivity tester.

Set the switch to
"4 poles"

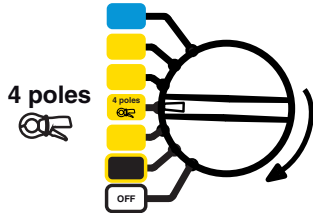

Place electrodes H and S at least 30m apart so that the potential wells that form around them do not intersect.

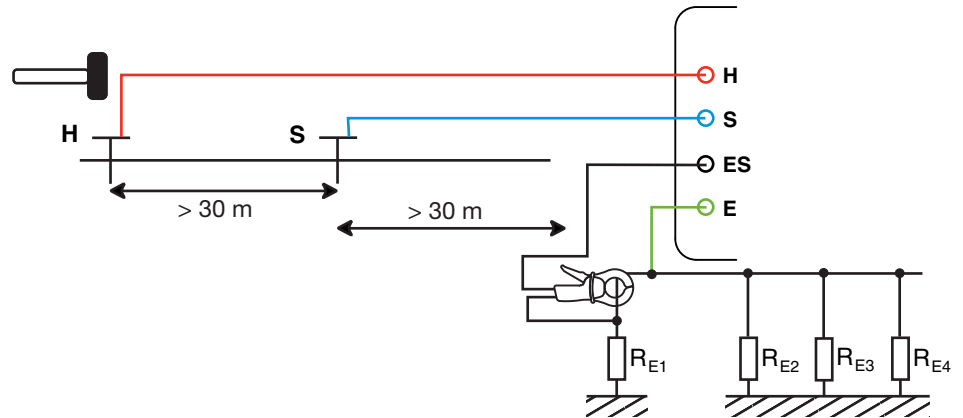

In order to avoid electromagnetic interference, it is best to unwind the full length of each cable from the reel, to keep the cables as far apart as possible on the ground, taking care not to form loops, and to avoid placing the cables near or parallel to metallic conductors (cables, rails, fences, etc.).

Connect the cables to terminals H and S. Connect a cable between terminal E and the earth. Connect the clamp to terminal ES; the device recognises it automatically. Clamp the path of the earth to be checked. Connect the socket of the current clamp to this same path (connection to terminal ES). Take care not to place the cable of electrode H too close to the current clamp; this is in order to avoid any transmission of the AC signal to the clamp (especially if you use an MN82 clamp).

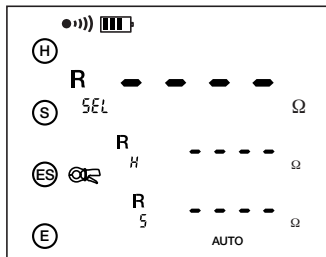

Start the measurement
by pressing the START/
STOP button.

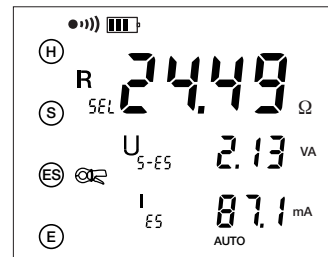

$R_{SEL} = R_{E1}$
In the case of the
diagram above.

You can now move the clamp and its lead to measure
the other earth resistances, R_{E2} , R_{E3} , etc.



To display the measurement parameters, press the DISPLAY key several times.

The device displays the following quantities (see the glossary, §12):
 R_{SEL} , U_{S-ES} , I_{H-E} , R-Act (R_{PASS}), U-Act (U_{H-E} and its frequency), I-Act (I_{ES} and its frequency).
Plus R_{E1} , R_H , R_S , U_{E-S} if the measurement was started by a long press of START/STOP.

To measure the resistances of electrodes H and S, or if the resistance of the electrodes is too large (see §4), start the measurement with a **long press** of the START/STOP button.

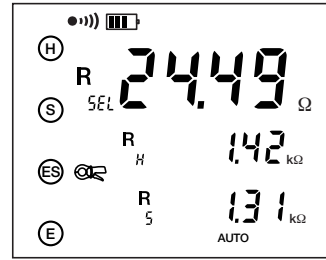
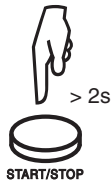

3.4. MEASUREMENT OF SOIL RESISTIVITY ρ

To measure the resistivity of the soil, you can choose between the Wenner and Schlumberger methods. The difference between the two methods lies in the positioning of the electrodes. By default, the device selects the Wenner method, but if you want to vary the distance between the electrodes, use the Schlumberger method, which allows you to move only 2 measurement electrodes rather than 3.

The soil resistivity measurement with different distances d , and therefore in different layers (in depth) of the soil, can be used to establish resistivity profiles of the soil in question, which can be useful for geological analysis, the exploration of deposits, hydrological studies, etc., and to determine the location of an earth electrode.

3.4.1. CHOICE OF MEASUREMENT METHOD

By default, the Wenner method is selected. To select the Schlumberger method, proceed as follows:

Set the switch to ρ .

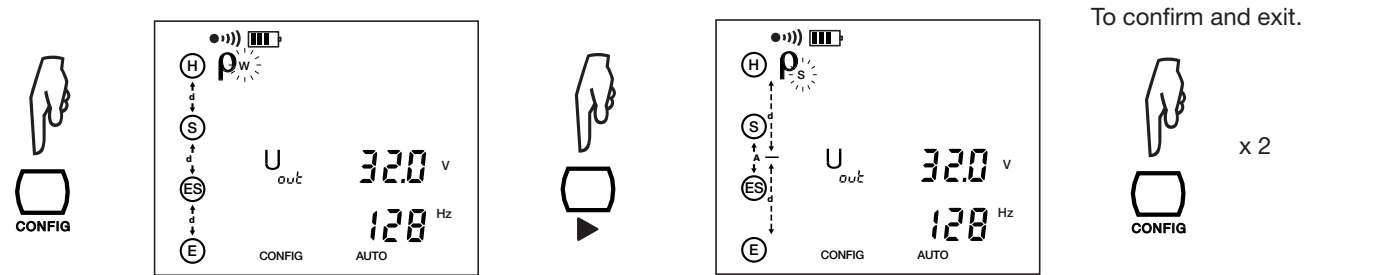
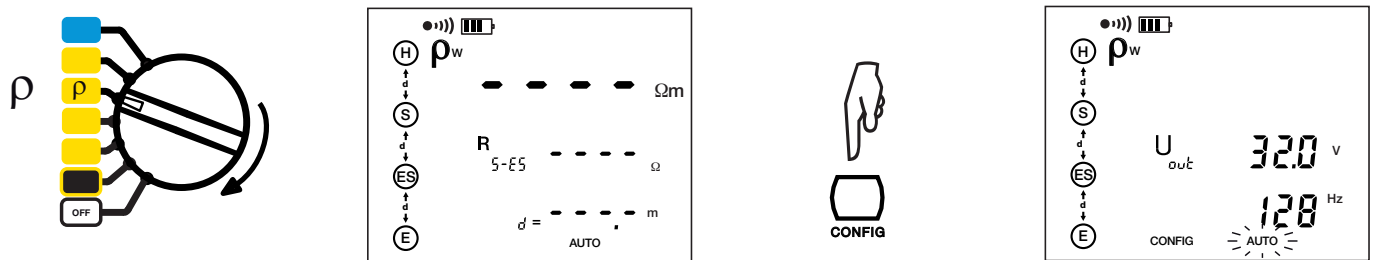

To confirm and exit.

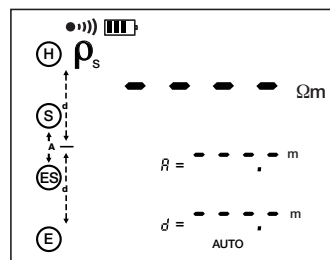
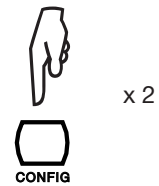

To switch back to the Wenner method, simply repeat this procedure.

The last measurement method selected (Wenner or Schlumberger) is stored in memory when the device is switched off.

3.4.2. PROGRAMMING OF THE DISTANCE

The distance can be programmed before or after the measurement. If it is not programmed, only the value of R_{S-ES} will be displayed, since the value of ρ remains indeterminate.

Set the switch to ρ .

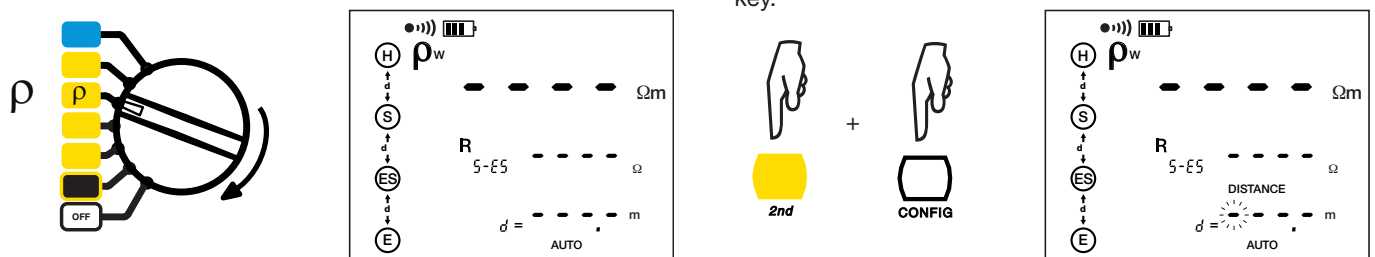

To select the hundreds (of metres).

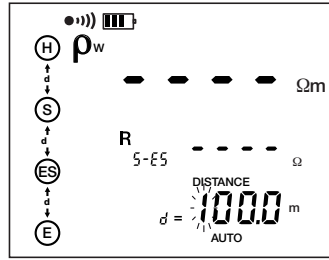

To select the tens.

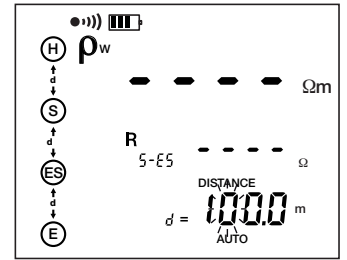
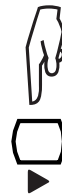

To modify the tens.

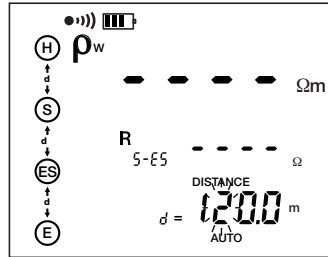

To select and modify the metres and tenths of a metre.



puis

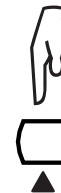

To terminate the programming of the distance.

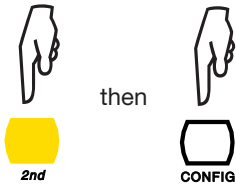

In the case of the Schlumberger method, it is also necessary to program distance A. This is done in the same way as for distance d.

3.4.3. WENNER METHOD

Set the switch to ρ .

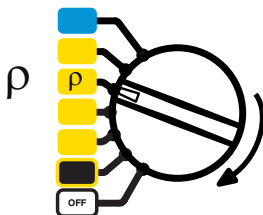

Place the 4 earth electrodes on a straight line, at a distance d from one another and at a depth p < 1/3 d. Distance d must be between 2 and 30m. Connect the cables to the electrodes, then to terminals H, S, ES, and E.

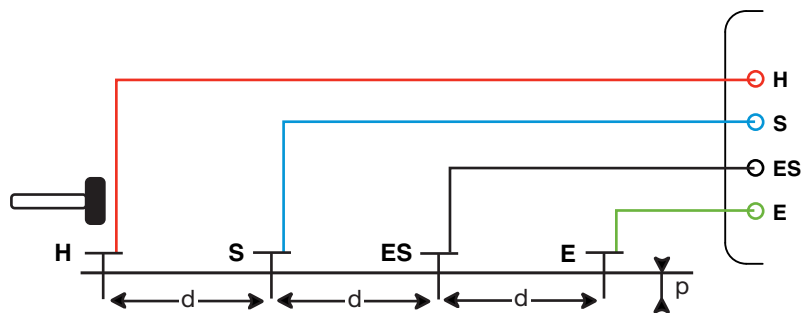

In order to avoid electromagnetic interference, it is best to unwind the full length of each cable from the reel, to keep the cables as far apart as possible on the ground, taking care not to form loops, and to avoid placing the cables near or parallel to metallic conductors (cables, rails, fences, etc.).

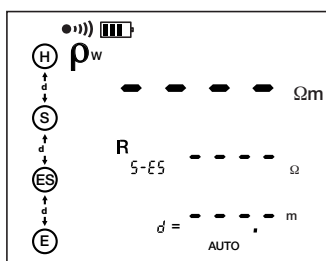

Program distance d and start the measurement by pressing the START/STOP button.

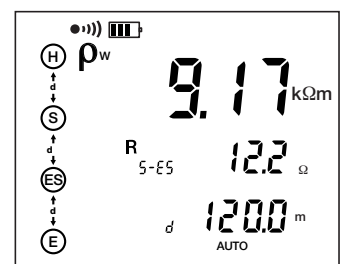

$$\rho_w = 2 \cdot \pi \cdot d \cdot R_{S-ES}$$



To display the measurement parameters, press the DISPLAY key several times.



The device displays the following quantities (see the glossary, §12):
 ρ_w , R_{S-ES} , d , U_{S-ES} , I_{H-E} , U-Act (U_{S-ES} and its frequency, U_{H-E} and its frequency).



To measure the resistances of electrodes H, S, ES, and E, or if the resistance of the electrodes is too high (see §4), start the measurement by a long press of the START/STOP button.

The device displays R_{P-E} and R_{P-H} , then R_{P-ES} and R_{P-S} .

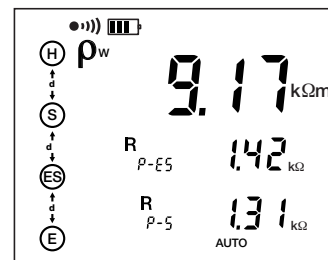
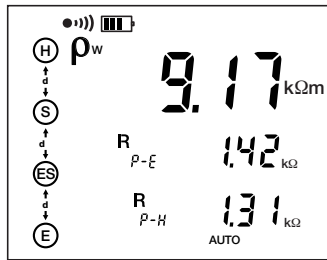

Metallic elements in the ground (railway lines, pipes, etc.) or underground water courses may influence the resistivity of the soil in a given direction. We therefore recommend making another measurement, with the electrodes aligned 90° from the first measurement, to detect any directional effects. We also recommend making several measurements, with different distances d , to eliminate local effects that might interfere with the measurement.

The greater the distance between the electrodes and the deeper they are driven, the better the result for the deeper layers of the ground.

3.4.4. SCHLUMBERGER METHOD

Set the switch to ρ .

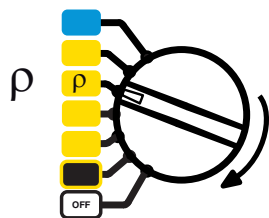

Place electrodes S and ES at a distance A apart. Then place electrodes H and E in the same straight line, at a distance d measured from the midpoint of distance A . Distance d must be between 2 and 30m. Drive the electrodes to a depth p of not more than 1/3 of d . Connect the cables to the electrodes, then to terminals H, S, ES, and E.

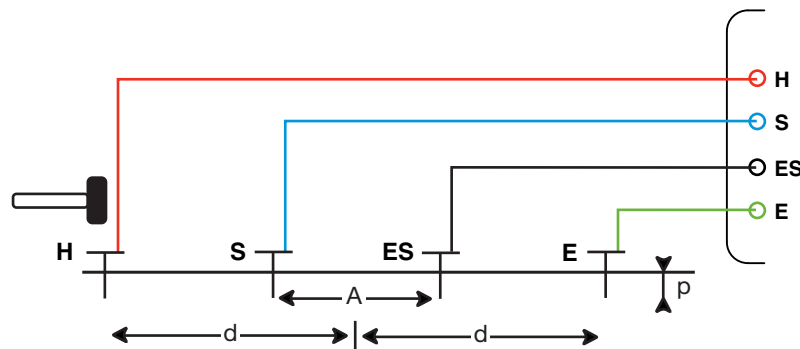

In order to avoid electromagnetic interference, it is best to unwind the full length of each cable from the reel, to keep the cables as far apart as possible on the ground, taking care not to form loops, and to avoid placing the cables near or parallel to metallic conductors (cables, rails, fences, etc.).

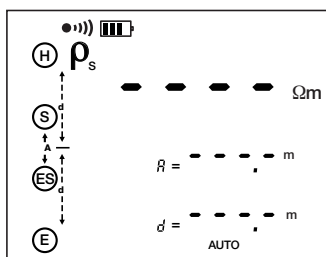

Program distance d and A (see §3.4.2.).

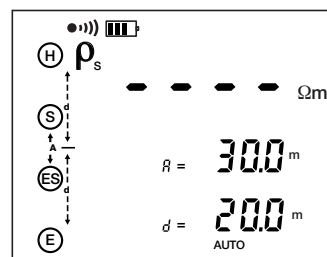

Start the measurement by pressing the START/STOP button.



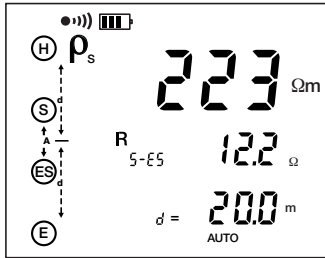

To display the measurement parameters, press the DISPLAY key several times.

The device displays the following quantities (see the glossary, §12): ρ_s , R_{S-ES} , d , A , U_{S-ES} , I_{H-E} , U_{Act} (U_{S-ES} and its frequency, U_{H-E} and its frequency).

$$\rho_s = \pi \cdot \frac{d^2 - \frac{A^2}{4}}{A} \cdot R_{S-ES}$$

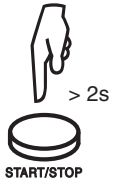

To measure the resistances of electrodes H, S, ES, and E, or if the resistance of the electrodes is too high (see §4), start the measurement by a long press of the START/STOP button. The device displays R_{P-E} and R_{P-H} , then R_{P-ES} and R_{P-S} .

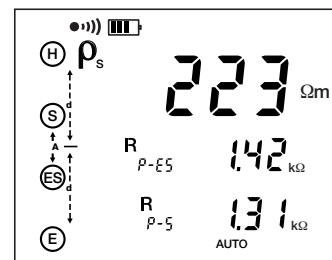
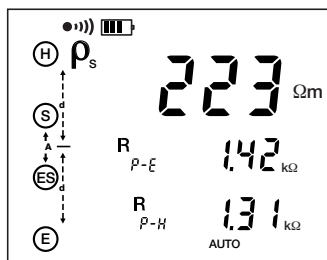

3.5. EARTH MEASUREMENTS WITH 2 CLAMPS

This is a rapid way to measure the value of the earth (any error will be on the high side) without the need of an electrode.

The current clamp connected to terminal H applies a voltage to the circuit to be measured. The value of the resulting current is determined by the impedance of the circuit to be measured. The current flowing in the loop is measured using the clamp connected to terminal ES. The device then calculates loop resistance R_{LOOP} from these quantities.

Use only C182 or MN82 current clamps; they are specially designed to operate with the C.A 6471.

Set the switch to 2 clamps.

Connect a clamp to terminal H and clamp the earth. Connect the other clamp to terminal ES and clamp the part of the global earth to be measured.

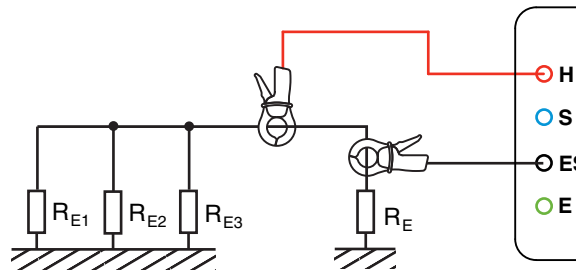
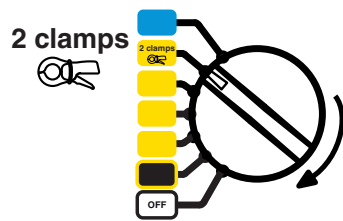

Observe the following minimum distances between the two clamps in order to avoid direct electromagnetic influences between the transmitting clamp and the receiving clamp:

Value measured (Ω)	Minimum separation (m)	
	MN82	C182
0 - 1	0.1	0
1 - 5	0.4	0.1
5 - 10	0.5	0.2
10 - 50	0.7	0.3
50 - 100	0.9	0.5
100 - 500	1.2	0.5

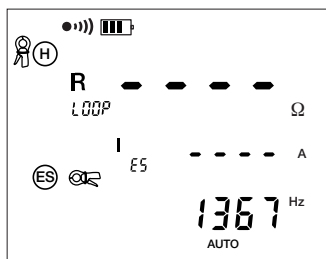

Start the measurement by pressing the START/STOP button.

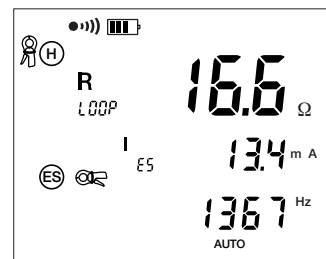

In the case of the diagram above, the earth impedance measured is equal to:

$$R_{LOOP} = R_E + (R_{E1} // R_{E2} // R_{E3})$$



To display the measurement parameters, press the DISPLAY key several times.

The device displays the following quantities (see the glossary, §12): R_{LOOP} , I_{ES} and its frequency, I-Act (I_{ES} and its frequency).

Remark: in the automatic mode, the measurement frequency is 1611 Hz. To make an earth measurement that is free of inductive effects, you must change to manual mode and choose a lower measurement frequency (see §5.1).

4. ERROR REPORTING

4.1. ELECTRODE RESISTANCE TOO HIGH

This can happen in a 3- or 4-pole earth measurement, or a resistivity measurement.



This message is displayed when the measurement was triggered by a short press on the START/STOP button and the resistances of the electrodes are too high. The measurement must then be started by a long press on the START/STOP button. The device then measures the values of the electrodes and compensates for them to display the correct result.

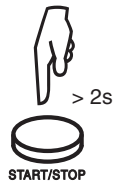

4.2. OUT OF RANGE



or



The flashing > or < symbol indicates the measurement is out of range.



and



If both symbols flash together, it means that the accuracy of the value displayed is outside of the instrument specification or is subject to large fluctuations. Activating the smoothing function (SMOOTH) may correct this.



4.3. MISCONNECTION



This flashing indicates that a terminal or a current clamp needs to be either connected or disconnected. You must correct the connections or the measurement will not proceed.

The flashing of terminal H may also indicate that current I_{H-E} is too low. The flashing of terminal S may also indicate that resistance R_S is too high. The flashing of terminal ES may also indicate that the current I_{ES} measured by the clamp is too low.

To reduce R_H , you can add one or more electrodes, 2 metres apart from each other, in the H leg of the circuit, or increase the test voltage.

To reduce R_S , you can add one or more electrodes, 2 metres apart from each other, in the S leg of the circuit.

To reduce the resistance of the electrodes, you can also drive them deeper, pack the ground around them well, or dampen them with water.

4.4. INDICATORS OF LIMITS OF USE



This flashing during a **passive** measurement means that the device has detected the presence of an external voltage exceeding 42V on the terminals and that the measurement is impossible.

This flashing during an **active** measurement means that the operating limits have been exceeded.



If this symbol remains lit during an active measurement, it means that the values measured are subject to large fluctuations or that there is an incorrect connection.



The display of an indefinite value for a passive measurement indicates that measurement current I_{ES} or voltage U_{S-ES} is too low.











NOISE

The display of the NOISE symbol indicates that a spurious external voltage is likely to interfere with the measurement. You should change to manual mode and change the measurement voltage and/or frequency in order to make a valid measurement.

After the measurement has started there are indicators of when:

- Values R_H and/or R_S are too high,
- Measurement current I_{H-E} or I_{ES} is too low,
- The instability of the measurement is large.

Those conditions that may give uncertain results are indicated on the display of the unit as follows:

Function	Triggering threshold	Indication on the display unit
3P, 4P, ρ	$I_{H-E} < 1 \text{ mA}$	 flashes ⁽³⁾  flashes
4P sel	$I_{H-E}' < 1 \text{ mA}^{(1)}$	
All	$R_S > 30 \text{ k}\Omega$	 flashes ⁽³⁾  flashes
4P sel	$I_{ES} < 1 \text{ mA}$	 flashes ⁽³⁾  flashes
All	Values measured (U, I, R) unstable, varying by more than 5% about their mean values. ⁽²⁾	 steady ⁽³⁾  flashes
R_{PASS}	$I_{ES} < 3 \text{ mA}$ $U_{S-ES} < 10 \text{ mV}$	 flashes
R_{PASS}	$I_{ES} < 0,3 \text{ mA}$ $U_{S-ES} < 1 \text{ mV}$	-.--- (undefined)
All	$U_{S-ES}, U_{S-E}, U_{H-E} > 42 \text{ V}$	 flashes ⁽³⁾
All	Spurious voltage of which the frequency and/or value is likely to interfere with the measurement.	NOISE ⁽⁴⁾

(1) I_{H-E}' : current I_{H-E} measured at the start of the measurement before I_{ES} .

(2) Not active if the SMOOTH function is selected.

(3) The symbol  may also appear if there is an external voltage $> 42 \text{ V}$ on the terminals of the device.

(4) You should change to manual mode and modify the measurement voltage and/or frequency to make a valid measurement (when the NOISE symbol is no longer illuminated).

5. MEASUREMENTS IN MANUAL MODE

It is possible to modify the parameters of all of the measurement functions described for the automatic mode in §3 by changing to manual mode.

To access the manual mode, press the CONFIG key. The CONFIG symbol is displayed and the AUTO symbol flashes. By pressing the ► key, you can change to manual mode (display of the MANUAL symbol).

In manual mode, the device toggles between the parameters to be modified (dependant upon the measurement function) by successive presses on the CONFIG key.

When you trigger a measurement in manual mode, by a short or long press on the START/STOP button (the circular arrows on the display will rotate), you can stop the measurement by a second press of this button.

Whenever a new measurement function is selected, the device automatically changes back to automatic mode.

5.1. CHOICE OF MEASUREMENT FREQUENCY

Functions concerned: all except mΩ.

If the device cannot make a valid measurement because of spurious signals of a frequency that interferes with the measurement, it displays the NOISE symbol. It also displays the frequency of the spurious signals. You can then change the frequency of the test voltage and start another measurement to obtain a valid result.

In the automatic mode, the device automatically chooses another frequency, while in the manual mode it is the operator who must choose another frequency. The NOISE symbol flashes for as long as spurious signals are present.

To change the frequency, change to manual mode and press the CONFIG key until the frequency flashes. Choose the frequency by pressing the key ►:

- USr, 55, 92, 110, 119, 128 Hz (128 Hz is default).
- 128, 1367, 1611, 1758 Hz for the 2-clamps function (1611 Hz is default).

To change the user frequency (USr), press the ▲▼ key (press the ▲▼ key to raise the value and 2nd + ▲▼ to lower it). The values available are stated in the table below.

Table of possible user frequencies USr (48 values from 41 Hz to 513 Hz):

41	43	46	49	50	55	60	61	64	67	69	73	79	82	85	92
98	101	110	119	122	128	134	137	146	159	165	171	183	195	201	220
238	244	256	269	275	293	317	330	342	366	391	403	439	476	488	513

For soil resistivity measurements, the user frequency is limited to 128 Hz.

There are therefore 2 user frequencies: one for resistivity and one for earth. These two values remain in memory even after the device is switched off.

5.2. SWITCHING OF THE MEASUREMENT VOLTAGE

Functions concerned: all except mΩ and 2 clamps.

When the device is used in a damp environment, we recommend lowering the test voltage from 32 to 16 V. To do this, change to manual mode and press the CONFIG key until the output voltage (Uout) flashes. Choose the voltage, 16 or 32 V, by pressing the ► key. This voltage setting is then valid for all functions concerned and all operating modes (automatic and manual). It is retained in the memory even after the device is switched off.

5.3. MANUAL SETTINGS FOR THE RESISTANCE MEASUREMENT

In manual mode, successive presses on the CONFIG key let you access the following parameters and change them using the key ►:

- Symbols of terminals H and E flash (2-point measurement) → H S ES E flash (4-point measurement)
- POS on H and DC+ flash → nEg on H and DC- flash (reversal of polarity on terminal H)

5.3.1. OUTPUT VOLTAGE POLARITY

By default, output voltage U_{HE} is positive.

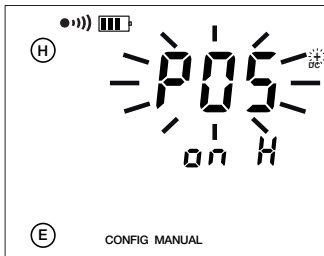

It is possible to make it negative.

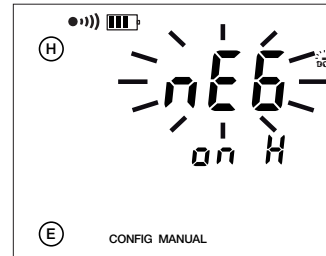

In manual mode, the device does not automatically invert polarity. But you can do so manually by pressing the CONFIG key in the course of the measurement.

5.3.2. CONTINUITY CHECK

The 2-wire $m\Omega$ measurement gives a rapid measurement result, accompanied by an audible beep, during a continuity check. The display is in a single range (0.5Ω to $1.99k\Omega$) and the check of the terminals is limited to terminal H (a cable must be connected to it), making it possible to start the measurement with the circuit open.

For a continuity check, the following settings are essential (see § 3.1.3 and 7.2):

- The 2-wire $m\Omega$ measurement function must be selected,
- The device must be in manual mode,
- The alarm function must be active (On),
- The alarm threshold must be low (<),
- The buzzer must be activated (bEEP On).

5.4. MANUAL SETTINGS FOR THE 3P EARTH MEASUREMENT

5.4.1 3-POLE EARTH MEASUREMENTS

In the manual mode, successive presses on the CONFIG key serve to access the following parameters, which can be changed using the ► key:

- EARTH flashes → Measurement of earth coupling
- 128 Hz flashes → Change of test frequency
- Test voltage flashes → Change of test voltage

5.4.2. MEASUREMENT OF EARTH COUPLING

This measurement calls for making and storing 3 intermediate measurements (at the same frequency). It is available only in manual mode.

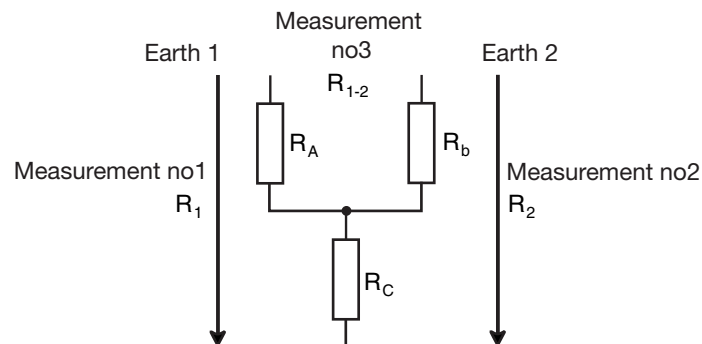

After switching from EARTH to EARTH COUPLING, using the CONFIG and ► keys, proceed as follows:

- If you want to eliminate the resistance of the measurement leads, you can use lead compensation (2nd + START) before starting the actual coupling measurement (see §3.1.2).
- Set the function switch to the “3-pole” position.
- You may choose a test frequency (see §5.1) and a test voltage (see §5.2).
- The screen displays EARTH COUPLING 1. Make a 3-pole earth measurement on the first earth system (measurement of R_1 in the connection diagram above). Stop the measurement by pressing the START/STOP button. The MEM symbol flashes to indicate that this result must be recorded in memory. Press the MEM key twice. To save to another location, refer to §7.
- The screen now displays EARTH COUPLING 2. Make a 3-pole earth measurement on the second earth system (measurement of R_2). For this second measurement, leave the H and S electrodes in the same positions as for the first measurement. Store this result in the same memory location as before by pressing the MEM key twice.
- The screen now displays the message EARTH COUPLING 3. Disconnect terminal S and make a 2-wire resistance measurement with terminal H connected to earth 1 and terminal E to earth 2. Record this result by pressing the MEM key twice.
- The screen displays EARTH COUPLING 4 and the results of the measurements.

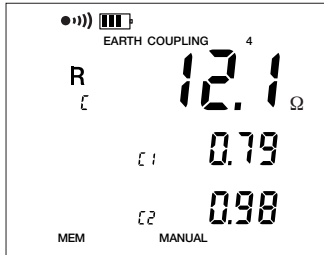

The coupling calculation uses the following formulas:

$$R_c = (R_1 + R_2 - R_{1-2})/2$$

$$C_1 = R_c/R_1 \text{ et } C_2 = R_c/R_2 \quad R_A = R_1 - R_c$$

$$R_b = R_2 - R_c$$



To display the calculated parameters, press the DISPLAY key several times.

The device displays the following quantities (see the glossary, §12): R_c , C_1 , C_2 , R_A , R_b , U_{OUT} and its frequency.

To display all of the measurement parameters, press the MR key.

To scroll all of the measurements.

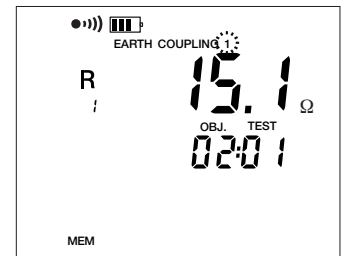
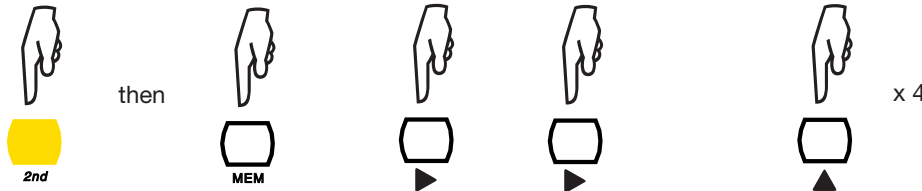

To display the parameters of each of the measurements, press the DISPLAY key several times. The device displays the following quantities (see glossary, §12):

- EARTH COUPLING 1: R_1 , U_{OUT} and its frequency, U_{S-E} , I_{H-E} , U-In (U_{S-E} and its frequency) R_H and R_S if long press of START/STOP
- EARTH COUPLING 2: R_2 , U_{OUT} and its frequency, U_{S-E} , I_{H-E} , U-In (U_{S-E} and its frequency) R_H and R_S if long press of START/STOP
- EARTH COUPLING 3: R_{1-2} , U_{H-E} and its frequency, I_{H-E} , U-In (U_{H-E} and its frequency).
- EARTH COUPLING 4: R_c , C_1 , C_2 , R_A , R_b , U_{out} and its frequency.

5.5. MANUAL SETTINGS FOR THE 4P EARTH MEASUREMENT

In the manual mode, successive presses on the CONFIG key let you access the following parameters and change them using the ► key:

- 128 Hz flashes → Change of test frequency
- Test voltage flashes → Change of test voltage

5.6. MANUAL SETTINGS FOR THE SOIL RESISTIVITY MEASUREMENT

In the manual mode, successive presses on the CONFIG key let you access the following parameters and change them using the ► key:

- ρ_w flashes (Wenner method) → Switching to ρ_s (Schlumberger method)
- 128 Hz flashes → Change of test frequency
- Test voltage flashes → Change of test voltage

5.7. MANUAL SETTINGS FOR THE MEASUREMENT WITH 2 CLAMPS

In the manual mode, successive presses on the CONFIG key let you access the frequency and change it using the ► key:

- 1611 Hz flashes → Change of test frequency

5.8. SMOOTHING

In the manual mode, you can activate or deactivate the smoothing of the measurement results by pressing the 2nd + DISPLAY (*SMOOTH*) keys. This smoothing consists in displaying an exponential mean value, a significant help with highly fluctuating values.

6. MEMORY FUNCTION

The device has a total of 512 memory locations. Each of these locations is defined by an object number (OBJ) from 01 to 99 and by a TEST number from 01 to 99.

During resistivity measurements (Wenner or Schlumberger methods), several measurement results are recorded at the same memory location, with the distance between electrodes as the third addressing criterion.

For earth coupling measurements (EARTH COUPLING 1, 2, 3, 4), the four measurements provide the third addressing criterion for the same memory location.

None of the other measurements has an additional addressing criterion, so each occupies only one memory address.

Since each measurement is dated, you must set the date and time of the device before any storage in memory (see §7.1).

6.1. STORAGE OF MEASUREMENT RESULTS

After each measurement, ...

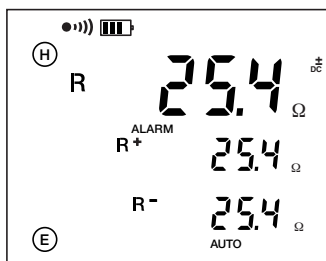

... the complete result can be stored by pressing the MEM key.



The device automatically proposes the first free location in memory (FrEE OBJ: TEST).

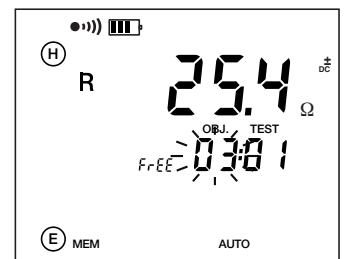

Press the MEM key a second time to record.



Press the DISPLAY key to exit from the MEM mode without recording.



Use the ► and ▲▼ keys to change the memory location.

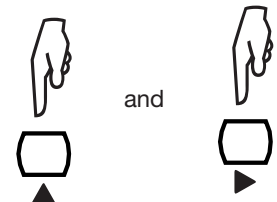

If the memory location chosen is already occupied, you can overwrite it by pressing MEM, unless the measurement includes 3 addressing criteria.

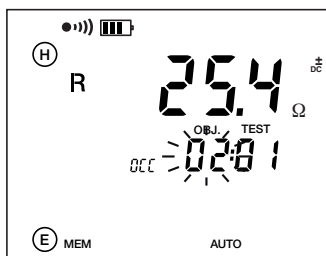

For soil resistivity and potential measurements, if you make several measurements with different distances d , you can store them under the same OBJ:TEST number, with the distance as third addressing criterion.

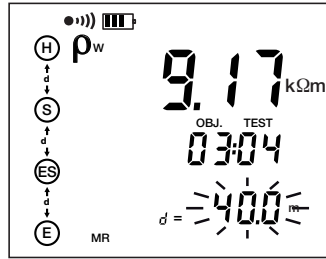

It will subsequently be possible to overwrite values already stored with new ones having the same distance d , or even to add new results having other values for the distance d provided that all of the other measurement parameters are identical.

6.2. RETRIEVAL OF STORED RESULTS

When a measurement function has been selected using the switch, the *MR* (2nd + MEM) key can be used to retrieve only the results stored in this function.

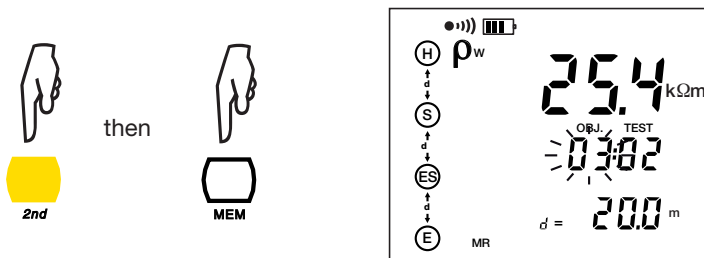

The ▲▼ key is used to change the item that is flashing and the ► key is used to choose what you want to change: OBJ, TEST, or the third addressing criterion (the distance in the example opposite).

Pressing the DISPLAY key displays the measurement time (tiME), year (dAtE), and date in mm.dd form.

To display the measurement and its parameters.

To exit from the memory retrieval mode at any time.

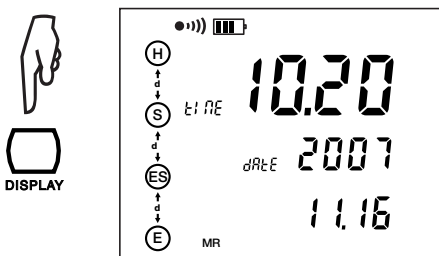

The SETUP function (see §7) lets you read all memory addresses one after the other independently of which measurement function is chosen.

6.3. ERASURE OF THE MEMORY

There are two ways to erase the internal memory of the tester:

6.3.1. COMPLETE ERASURE

Set the switch to SET-UP.

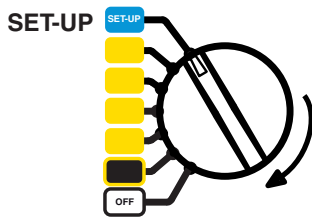

Press the MEM key to display the number of memory spaces available.

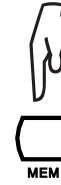

Press the MEM key again.



To perform a complete erasure of the memory.

(long press)

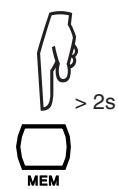
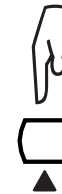

To exit without erasing
(short press).



6.3.2. PARTIAL ERASURE

Set the switch to SET-UP.

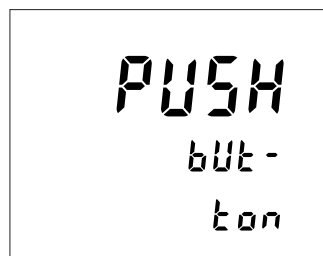
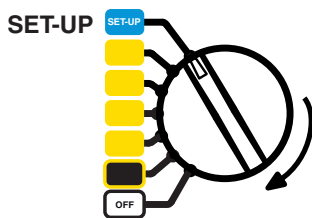

Press the MR key to display all occupied memory locations, independently of the measurement function.



Use the ► and ▲▼ keys to select the record to be erased.

Press the MEM key.

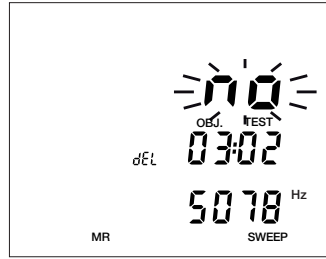

To erase the selected record.
 In the case of a record having a third addressing criterion,
 only the one displayed will be erased.

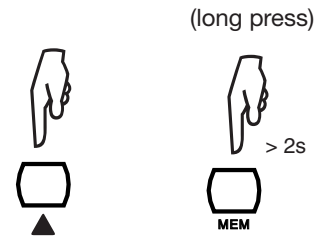

To exit without erasing
 (short press).



7. CONFIGURATION (SETUP)

Set the switch to SET-UP. The device prompts you to press a key with the following message:

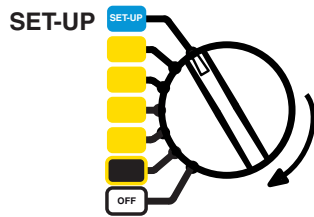

7.1. PRESS THE CONFIG KEY

The CONFIG key is used to set the date, the time, and the data transfer rate. It is also used to reset the device to the factory settings, but the date, the time, and any stored measurement results will be kept.

Use the **▶** key to choose the digit to be changed and increment or decrement it with the **▲▼** key, or, as the case may be, change the word proposed (for example ON or OFF) using the **▲▼** key.

The date: year, month, and day.



The time.



The data rate: 9.6k, 19.2k, and 38.4k



Reset of the device to the factory settings.

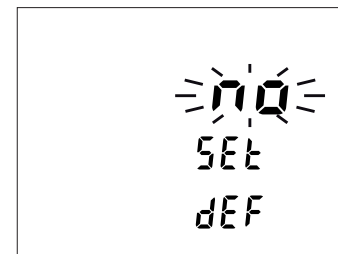

7.2. PRESS THE DISPLAY KEY

You can change the flashing parameter using the **▲▼** key, and choose the parameter to be changed using the **▶** key.

The distance can be expressed in metres (m) or in feet (ft).

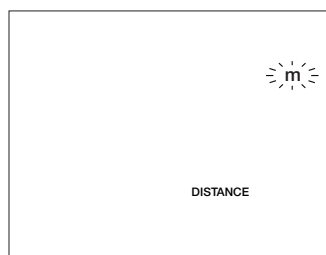

The alarm is used in the 2-wire resistance measurement. You can activate the alarm (On) or de-activate it (OFF), choose its direction, high (>) or low (<), and its value (between 1 and 999Ω). See §3.1.3.



The buzzer can be activated (On) or deactivated (OFF).

You can choose the bus address of the device (for communication with a PC) between 1 and 247.

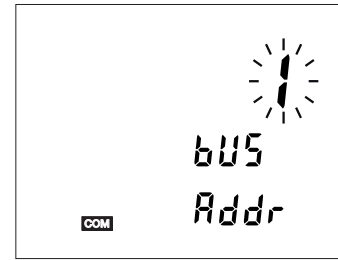

7.3. PRESS THE MEM KEY

By pressing the MEM key, you can display the level of occupancy of the memory of the device and possibly erase all records (see §6.3.1).

7.4. PRESS THE MR KEY

By pressing the MR key, you can display all of the records and erase them individually (see §6.3.2).

7.5. INTERNAL PARAMETERS

This information is important for any calibration or repair work on the tester.

If you keep the CONFIG key pressed while turning the switch to the SET-UP position, ...

... The device displays its internal software version number (SOft) and its serial number (InSt) on two lines.



+

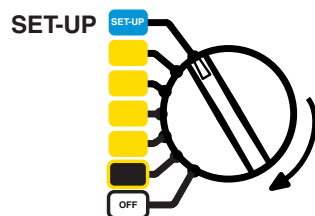

7.6. CHECK OF THE DISPLAY UNIT

If you keep the DISPLAY key pressed while turning the switch to the SET-UP position, ...

... the device displays all segments of the display unit until you leave the SET-UP position or press any key.



+

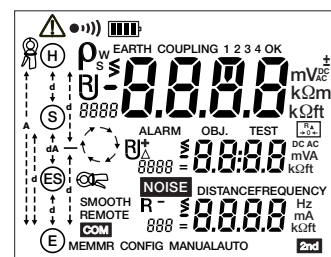
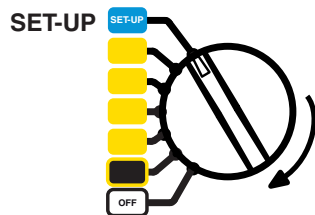

8. ERROR MESSAGES

When started up, the C.A 6471 device automatically performs a self-test. If a fault appears during this self-test or during a measurement, the device displays a message in the form Err XX.

There are 3 categories of errors:

- **Harmless** **Errors 6, 7 and 11**
The message appears for approximately 1 second to inform the user. Consider a repair if the error recurs.
 - Errors 6 and 7 are always preceded by an automatic reset.
 - During error 11, the device itself performs a reset to the default values.

- **Recoverable** **Errors 5, 14, 15, 18, 19, 30, 31, 32, and 33**
The error concerns the current measurement function and disappears if the function is changed. The device can therefore be used, but a repair will be necessary if the error persists.
 - Error 18 reports that it is impossible to recharge the internal battery of the device. If error 18 is reported during the recharging of the battery, disconnect the cord from line power and proceed as described below for “fatal” errors.
 - In the case of error 19, a complete erasure of the records may be a solution.
 - In the case of errors 31, 32, and 33, a voltage or current that is too high occurred during a measurement. Check your measurement circuit in this case.

- **Fatal** **Errors 0, 1, 2, 3, 8, 12, 13, 15, 16, 18 (during recharging of the batteries), and 21**
These errors prevent any operation. Stop the device and switch it back on. If the error persists, a repair is necessary.

9. CONNECTION TO A PC AND ANALYSIS SOFTWARE

You will find more detailed information about connection to a PC, remote control of the tester by a PC, reading measurement results stored in the device, and the modification of certain data in the memory in the documentation of DataView software for earth testers.

10. SPECIFICATIONS AND TECHNICAL CHARACTERISTICS

10.1. REFERENCE CONDITIONS

Quantities of influence	Reference values
Temperature	20 ± 3 °C
Relative humidity	45 to 55 % RH
Supply voltage	9 to 11,2 V
Frequency band of the input signal	0 to 440 Hz
Capacitance in parallel with the input resistance	0 µF
Electric field	< 1 V/m
Magnetic field	< 40 A/m

In the paragraphs that follow, the intrinsic error is defined under the reference conditions and the operating error under the operating conditions in accordance with IEC standard 61557 -1, -4, and -5.

10.2. ELECTRICAL CHARACTERISTICS

10.2.1. FREQUENCY MEASUREMENTS

Measurement method: digital by sampling at 4028 Hz, low-pass filter, FFT.
 The frequency displayed is that of the spectral component having the greatest amplitude.
 Measurement cycle: approximately 3 displays per second.

Measurement range	5 to 450 Hz
Resolution	1 Hz
Operating error	± 2 Hz
Minimum input voltage	10 mV
Minimum current in the current clamp	0.5 mA

10.2.2. VOLTAGE MEASUREMENTS

Voltage overloads up to 75 V_{rms} are displayed by: "> 65 V". Permanent voltage overloads between 70V and 75V on terminals H and E can overheat the protection varistance. They should therefore be avoided.

Voltages exceeding 75 V_{rms} trigger error message 31 (external voltage too high) or 32 (overshoot of voltage measurement range).

If terminals H and E are put into contact with the line voltage, the protection fuse blows.

All other terminals withstand the nominal line voltage without difficulty.

■ Measurement of external voltages

Measurement method: digital by sampling at 4028 Hz, low-pass filter, FFT.
 The frequency displayed is that of the spectral component having the greatest amplitude.
 Measurement cycle: approximately 3 displays per second.
 Conversion of the signal: TRMS or sum of all harmonics from 10 to 450 Hz during selective earth measurements with clamp.

Measurement range	0.00 – 9.99 V	10.0 – 65.0 V
Resolution	0.01 V	0.1 V
Intrinsic error	± (2% + 1 pt)	
Operating error	± (5% + 1 pt)	
Input impedance $Z_{H-E}, Z_{S-E} (Z_{S-ES})$	1.2 MΩ	
Service frequency	DC and 15 - 440 Hz	

■ Functional voltage measurements

The values of U_{H-E} , U_{S-E} and U_{S-ES} , used for DC and AC voltage resistance measurements, are called “functional voltages” and are measured by the instrument.

In all AC voltage functions, it is the fundamental frequency of the voltage created by the test signal that is measured.

The operating uncertainty of a functional voltage measurement may be greater than that indicated for an AC resistance measurement because, during the calibration of the instrument, the frequency characteristics of the voltage channel are matched to those of the current channel.

Measurement range	0.00 - 9.99 mV	10.0 - 99.9 mV	100 - 999 mV	1.00 - 9.99 V	10.0 - 65.0 V
Resolution	0.01 mV	0.1 mV	1 mV	0.01 V	0.1 V

Frequency band	DC and 41 – 513 Hz	537 – 5078 Hz
Intrinsic error	± (2% + 1 pt)	± (4% + 1 pt)
Operating error	± (5% + 1 pt)	± (7% + 1 pt)

10.2.3. CURRENT MEASUREMENTS

■ EXTERNAL CURRENT MEASUREMENTS

Measurement method: digital by sampling at 4028 Hz, low-pass filter, FFT.

Measurement cycle: approximately 3 displays per second.

Conversion of the signal: sum of all harmonics from 10 to 450 Hz.

■ With C182 current clamp

Measurement range	0.00 - 9.99 mA	10.0 - 99.9 mA	100 - 999 mA	1.00 - 9.99 A	10.0 - 40.0 A
Resolution	0.01 mA	0.1 mA	1 mA	0.01 A	0.1 A

Frequency band	16 - 49 Hz	50 - 99 Hz	100 - 400 Hz
Operating error from 0.5 to 100 mA	± (10% + 2 pt)	± (5% + 2 pt)	± (3% + 2 pt)
Operating error from 0.1 to 40.0 A	> 20%	± (10% + 2 pt)	± (5% + 2 pt)

■ With MN82 current clamp

Measurement range	0,00 - 9,99 mA	10,0 - 99,9 mA	100 - 999 mA	1,00 - 9,99 A	10,0 - 40,0 A ⁽¹⁾
Resolution	0,01 mA	0,1 mA	1 mA	0,01 A	0,1 A

Frequency band	16 - 49 Hz ⁽¹⁾	50 - 99 Hz ⁽¹⁾	100 - 400 Hz
Operating error from 0.5 to 100 mA	± (15% + 2 pt)	± (7% + 2 pt)	± (5% + 2 pt)
Operating error from 0.1 to 40.0 A	> 20%	± (15% + 2 pt)	± (7% + 2 pt)

(1): The C.A 6471 device cannot tell which clamp is connected to the instrument. In the case of the MN82 clamp, with currents > 10 A and frequencies < 100 Hz, there will therefore be no warning message. The user is responsible for ensuring observance of the limits of use of the MN82 current clamp.

■ FUNCTIONAL CURRENT MEASUREMENTS

The values of I_{H-E} and I_{ES} , used for DC and AC voltage resistance measurements, are called “functional currents” and are measured by the instrument.

In all AC current functions, it is the fundamental frequency of the current created by the test signal that is measured.

The operating error of a functional current measurement may be greater than that indicated for an AC resistance measurement because, during the calibration of the instrument, the frequency characteristics of the voltage channel are matched to those of the current channel.

Measurement method: digital by sampling at 4028 Hz, low-pass filter, FFT.

Measurement cycle: approximately 3 displays per second.

Measurement range	0.00 - 9.99 mA	10.0 - 99.9 mA	100 - 350 mA
Resolution	10 μ A	0.1 mA	1 mA

Frequency band	DC and 41 – 513 Hz	537 – 5078 Hz
Intrinsic error	± (2% + 1 pt)	± (4% + 1 pt)
Operating error	± (5% + 1 pt)	± (7% + 1 pt)

10.2.4. DC RESISTANCE MEASUREMENTS

Measurement method:	Voltage/current measurement (Standard IEC 61557 part 4).
Nominal output voltage:	16 Vdc (if $R < 22 \Omega$ the output voltage is reduced to 10 Vdc)
Max. output current:	>200 mA _{dc} for resistances < 20 Ω
Maximum overload (permanent):	50 V _{rms} (protection up to 250V is ensured)
Maximum inductive overload:	2 H
Maximum spurious voltage:	60 V _{peak} > 10 Hz
Automatic range selection:	approximately 5 s
Duration of measurement:	8 s with automatic polarity reversal
Measurement cycle:	3 per second in manual mode
Compensation of leads:	possible from 0 to 5 Ω
Adjustment of the alarm:	">" or "<" between 1 and 999 Ω

2-wire m Ω measurements

Measurement range	0.12 - 9.99 Ω	10.0 - 99.9 Ω	100 - 999 Ω	1.00 - 9.99 k Ω	10.0 - 99.9 k Ω
Resolution	0.01 Ω	0.1 Ω	1 Ω	10 Ω	100 Ω
Intrinsic error	± (2% + 2 pt)				
Operating error	± (5% + 3 pt)				

4-wire m Ω measurements

Measurement range	0.020 - 9.999 Ω	10.00 - 99.99 Ω	100.0 - 999.9 Ω	1.000 - 9.999 k Ω	10.00 - 99.99 k Ω
Resolution	0.001 Ω	0.01 Ω	0.1 Ω	1 Ω	10 Ω
Intrinsic error	± (2% + 2 pt)				
Operating error	± (5% + 5 pt)				

10.2.5. AC EARTH RESISTANCE MEASUREMENTS

Measurement method:	Voltage/current measurement (IEC 61557 part 5)
No-load voltage:	16 or 32 V _{rms} , rectangular voltage (for currents > 240 mA the output voltage is reduced to 10 V _{rms})
Test frequency:	choice of values from 41 to 513 Hz (see §5.1)
Short-circuit current:	> 200 mA _{ac}
Rejection of spurious signals:	> 80 dB for frequencies 20% or more above or below the test frequency
Max. acceptable overload:	250 V _{rms}
Maximum value for R_H and R_S :	100 k Ω
Duration: Short press on START:	approximately 7 s to the 1 st value of R_E at 128 Hz, then 3 measurements per second.
Long press on START:	approximately 15 s to the 1 st value of R_E at 128 Hz, then 3 measurements per second.

The following error indications apply to the reference conditions, with a test voltage of 32 V, a test frequency of 128 Hz, R_H and $R_S = 1 \text{ k}\Omega$, and no spurious voltage.

The operating error of an AC earth resistance measurement can be less than that indicated for the voltage or the current because, during the calibration of the instrument, the frequency characteristics of the voltage channel are matched to those of the current channel.

Measurement of resistance of auxiliary electrodes R_H , R_S

Measurement range	0.14 - 9.99 Ω	10.0 - 99.9 Ω	100 - 999 Ω	1.00 - 9.99 k Ω	10.0 - 99.9 k Ω
Resolution	0.1 Ω	0.1 Ω	1 Ω	10 Ω	100 Ω
Operating error	± (10% + 2 pt)				

For this measurement, keep the START key pressed for more than 2 s. Between 41 and 256 Hz, the resistances of the auxiliary

electrodes are measured at the test frequency set. At higher test frequencies, the resistance of the auxiliary electrodes is measured at 256 Hz.

3-pole earth resistance measurement R_E

Measurement range	0.09 - 9.99 Ω	10.0 - 99.9 Ω	100 - 999 Ω	1.00 - 9.99 k Ω	10.0 - 99.9 k Ω
Resolution	0.01 Ω	0.1 Ω	1 Ω	10 Ω	100 Ω
Intrinsic error	$\pm (2\% + 1 \text{ pt})$				

Operating conditions: $R_E < 3 \times R_H$, $U_{OUT} = 32 \text{ V}$			Operating error for R_E
Values for R_H , R_S and R_E		Frequency (Hz)	
$(R_H + R_S) / R_E < 3000$	$R_H \geq 0 \Omega$, $R_S \leq 3 \text{ k}\Omega$	41 - 513	$\pm (3\% + 2 \text{ pt})$
	$R_H > 3 \text{ k}\Omega$, $R_S \leq 30 \text{ k}\Omega$	41 - 513	$\pm (10\% + 2 \text{ pt})$
$(R_H + R_S) / R_E < 5000$	$R_H > 30 \text{ k}\Omega$, $R_S < 100 \text{ k}\Omega$	41 - 128	$\pm (10\% + 3 \text{ pt})$

Note: for a test voltage U_{OUT} of 16 V, halve value of R_H

4-pole earth resistance measurement R_E

Measurement range	0.011 - 9.999 Ω	10.00 - 99.99 Ω	100.0 - 999.9 Ω	1.000 - 9.999 k Ω	10.00 - 99.99 k Ω
Resolution	0.001 Ω	0.01 Ω	0.1 Ω	1 Ω	10 Ω
Intrinsic error	$\pm (2\% + 1 \text{ pt})$				

Operating conditions: $R_E < 3 \times R_H$, $U_{OUT} = 32 \text{ V}$			Operating error for R_E
Values for R_H , R_S and R_E		Frequency (Hz)	
$(R_H + R_S) / R_E < 3000$	$R_H \geq 0 \Omega$, $R_S \leq 3 \text{ k}\Omega$	41 - 513	$\pm (3\% + 2 \text{ pt})$
	$R_H > 3 \text{ k}\Omega$, $R_S \leq 30 \text{ k}\Omega$	41 - 513	$\pm (10\% + 2 \text{ pt})$
$(R_H + R_S) / R_E < 5000$	$R_H > 30 \text{ k}\Omega$, $R_S < 100 \text{ k}\Omega$	41 - 128	$\pm (10\% + 3 \text{ pt})$

Note: for a test voltage U_{OUT} of 16 V, halve value of R_H .

Selective 4-pole earth resistance measurement with C182 or MN82 clamp

Same characteristics as 4-pole earth measurements with the following particular conditions:

Minimum current: C182, $I_{ES} > 0.5 \text{ mA}$
 MN82, $I_{ES} > 2 \text{ mA}$

Maximum R_{SEL} / R_E ratio: C182, $(R_{SEL} / R_E) < 500$
 MN82, $(R_{SEL} / R_E) < 120$
 with $R_H + R_E < 20 \Omega$

10.2.6. MEASUREMENT OF SOIL RESISTIVITY ρ

Measurement method:	Voltage/current measurement (IEC 61557, part 5)
No-load voltage:	16 or 32 Vrms, rectangular voltage
Test frequency:	choice of values from 41 to 128 Hz (see §5.1)
Short-circuit current:	>200 mAac
Rejection of spurious signals:	>80 dB for frequencies 20% or more above or below the test frequency
Max. acceptable overload:	250Vrms
Maximum value for R_H , R_S , R_{ES} , R_E :	100k Ω (measurement error see §10.2.5)
Calculation by Wenner method:	$\rho_W = 2\pi d R_{S-ES}$
Calculation by Schlumberger method:	$\rho_S = (\pi (d^2 - (A/2)^2) / A) R_{S-ES}$
Maximum value of ρ :	999 k Ωm (display in k Ωft is not possible)
Duration: Short press on START:	approximately 8s to the 1st value of R_{S-ES} at 128 Hz, then 3 measurements per s.
Long press on START:	approximately 20s to the 1st value of R_{S-ES} at 128 Hz, then 3 measurements per s.

Measurement range	0.00 - 9.99 Ω	10.0 - 99.9 Ω	100 - 999 Ω	1.00 - 9.99 kΩ	10.0 - 99.9 kΩ
Resolution	0.01 Ω	0.1 Ω	1 Ω	10 Ω	100 Ω
Intrinsic error	± (2% + 1 pt)				

The intrinsic error indication is given for the reference conditions, with a test voltage of 32 V, a test frequency of 128 Hz, R_{P-H} , R_{P-S} , R_{P-ES} and $R_{P-E} = 1 \text{ k}\Omega$, and no spurious voltage.

Operating conditions $R_{S-ES} < 3 \times R_{P-H}$ and:	Operating error for R_{S-ES}
$R_{\text{electrode}} \leq 100 \text{ k}\Omega$ $R_{\text{electrode}} / R_{S-ES} \leq 2,000$	± (7% + 2 pt)
$R_{\text{electrode}} \leq 50 \text{ k}\Omega$ $R_{\text{electrode}} / R_{S-ES} \leq 10,000$	± (15% + 3 pt)
$R_{\text{electrode}} \leq 10 \text{ k}\Omega$ $R_{\text{electrode}} / R_{S-ES} \leq 20,000$	± (20% + 1 pt)

$R_{\text{electrode}}$ is the resistance of the earth electrodes R_{P-E} , R_{P-ES} , R_{P-S} , R_{P-H} , assumed identical.

Note: for a test voltage U_{OUT} of 16 V, halve value of $R_{\text{electrode}}$.

Measurement of resistance of auxiliary electrodes R_{P-H} , R_{P-S} , R_{P-ES} , R_{P-E}

Measurement range	0.14 - 9.99 Ω	10.0 - 99.9 Ω	100 - 999 Ω	1.00 - 9.99 kΩ	10.0 - 99.9 kΩ
Resolution	0.1 Ω	0.1 Ω	1 Ω	10 Ω	100 Ω
Operating error	± (10% + 2 pt)				

For this measurement, keep the START key pressed for more than 2 s. Between 41 and 128 Hz, the resistances of the auxiliary electrodes are measured at the test frequency set. At higher test frequencies, the resistance of the auxiliary electrodes is measured at 128 Hz.

10.2.7. EARTH MEASUREMENTS WITH 2 CURRENT CLAMPS

Measurement method:	Voltage/current measurement with rectangular AC signal
Induced short-circuit current:	< 26 Arms (with C182) and < 5 Arms (with MN82)
Frequency of the signal:	Automatic: 1611 Hz. Manual: 128, 1367, 1611 or 1758 Hz
Suppression of spurious signals:	> 80 dB for frequencies 20% or more above or below the test frequency
Maximum acceptable spurious current:	20 A _{peak}
Maximum value R_H , R_S :	100 kΩ (for measurement error see §10.2.5)
Duration of measurement:	approximately 7s for the 1 st value of R_{LOOP} then 3 measurements per s.

Measurement frequency		1367 Hz - 1611 Hz - 1758 Hz		
Measurement range		0,10 - 9,99 Ω	10,0 - 99,9 Ω	100 - 500 Ω
Resolution		0,01 Ω	0,1 Ω	1 Ω
Operating error ⁽¹⁾ (without spurious current)	C182	± (10% + 1 pt)		
	MN82	± (20% + 2 pt)		

Measurement frequency		128 Hz	
Measurement range		0,10 - 9,99 Ω	10,0 - 30,0 Ω
Resolution		0,01 Ω	0,1 Ω
Operating error ⁽¹⁾ (without spurious current)	C182	± (20% + 2 pt)	
	MN82	not specified	

(1): Observe the minimum distance between the two clamps indicated in the table of §3.6.

10.3. POWER SUPPLY

The instrument is powered by a rechargeable 9.6 V 3.5 Ah NiMH battery pack.

This has many advantages:

- long life with small size and weight,
- the possibility of recharging your battery rapidly,
- a very small memory effect: you can recharge your battery rapidly, even if it is not fully discharged, without reducing its capacity,
- protection of the environment: no polluting materials such as lead or cadmium.

The NiMH technology allows a limited number of charging/discharging cycles. The number depends on the conditions of use and on the charging conditions. Under optimum conditions, the number of cycles is 200.

The instrument has 2 charging modes:

- rapid charging: the battery recovers 90% of its capacity in 3h;
- maintenance charging: this mode cuts in when the battery is very low and at the end of rapid charging.

The device informs you, on the display unit, of the type of charging:

bAtt CHrG	Fast charging in progress (normal state).
bAtt LOW	Battery voltage too low for a fast charge → charging at a lower current.
bAtt	Battery voltage too high for a fast charge → charging at a lower current.
bAtt HOt	The battery is too hot for a fast charge (>40°C) → charging at a lower current.
bAtt COLd	The battery is too cold for a fast charge (<0°C) → charging at a lower current.
bAtt FULL	The battery is fully charged → maintenance charge.

The day before using your device, check its charge condition. If the battery symbol  now displays only one bar, or none, charge the device overnight (see §1.3).

Using a special power supply unit, the C.A 6471 device can also be recharged from a 12 Vdc outlet in a vehicle.

 In this case, the low-potential contact of the vehicle's 12 Vdc outlet is at the potential of inputs E and ES of the tester. As a precaution, the device must therefore not be used or connected if there is reason to suspect the presence of voltages exceeding 32 V on these inputs.

In order to make the most of your battery and extend its effective life:

-  ■ Use only the charger supplied with your device. The use of another type of charger may be hazardous!
- Charge your device only between 0° and +40°C.
 - Observe the conditions of use and of storage defined in this user guide.

The time between charges depends on the ranges:

Function	Power consumed	Typical number of measurements ⁽¹⁾
Device off	< 5 mW	-
Voltage measurement	1.5 W	4500
mΩ ⁽²⁾	4.9 W	1500
3 poles 4 poles ⁽³⁾	4.9 W	1500
ρ ⁽⁴⁾	4.9 W	1500
2 clamps	3.7 W	2000

(1): measurements in automatic mode at 25-s intervals.

(2): with R = 1Ω.

(3): with R_H + R_E = 100Ω.

(4): with R_H + R_{S-ES} = 100Ω.

10.4. ENVIRONMENTAL CONDITIONS

Use indoors or outdoors.

Range of use	0°C to +45°C and 0% to 90% RH
Specified operating range ⁽⁵⁾	0°C to +35°C and 0% to 75% RH
Storage (without battery)	-40°C to +70°C and 0% to 90% RH
Altitude	< 3000 m
Degree of pollution	2

(5): This range corresponds to the one defined by standard IEC 61 557, for which an operating error including the quantities of influence is defined. When the device is used outside this range, 1.5%/10°C and 1.5% between 75 and 90% RH must be added to the operating error.

10.5. CHARACTERISTICS OF CONTRUCTION

C.A. 6471 tester Dimensions (L x D x H): 272 x 250 x 128 mm
 Mass: approximately 3.2 kg

Index of protection PI 53 according to IEC 60 529
 IK 04 according to IEC 50102

Fall test according to IEC 61010-1
Vibrations according to IEC 61557-1

10.6. CONFORMITY TO INTERNATIONAL STANDARDS

Electrical safety as per IEC 61010-1.

Measurement according to IEC 61557 parts 1, 4 and 5.

Safety level categories: measurement category IV, 50V with respect to earth, 75V differential between terminals.

10.7. ELECTROMAGNETIC COMPATIBILITY

The instrument satisfies the EMC and LVD directives required for the CE marking and product standard IEC 61326-1.

- Immunity in industrial environment
- Emissions in residential environment.

11. TERMS AND DEFINITIONS

This section recalls the definitions of a few of the terms used in the context of earth measurements:

Earth conductor

The conductor that connects the installation to be earthed to its earth.

Earth contact (E)

The underground conductor that provides the electrical contact with the surrounding earth.

Earth measurement

The measurement made to check an earth; it may, depending on the situation, concern an individual earth contact or a complex earthing system.

Passive earth measurement

Measurement made using the spurious current flowing in the earthing installation.

Active earth measurement

Measurement made using a current from the internal voltage generator of the device, between terminals H and E.

Earth

A local group of interconnected earth contacts. An earth may be provided by metallic parts of an installation, such as the underground legs of pylons, metallic reinforcements (stays), foundations, the jackets of underground cables, earth conductors, etc.

Auxiliary earth electrode (H)

An auxiliary earth contact through which the measurement current flows.

Auxiliary earth electrode (S)

An auxiliary earth electrode used to measure the potential. The voltage proportional to the earth resistance to be determined is measured between electrode S and earth contact (E) or the auxiliary electrode (ES).

Auxiliary earth electrode (ES)

The measurement point connected to the earth or to an earthing system that is used to measure the electric potential existing at this point with respect to auxiliary earth electrode S.

Earth resistance

Resistance measured between the earth and reference earth.

Selective earth resistance

A partial resistance of an earth or of an earthing system. Its value can be measured by a selective measurement of the current flowing through this branch of the earthing circuit. Each selective earth resistance is by definition always greater than the total earth resistance (circuits in parallel).

Soil resistivity (specific) (ρ)

Can be represented by a cube 1 metre on a side filled with the soil in question, of which the resistance is measured between two opposed sides. The unit of measurement is the ohm-metre (Ωm).

Earthing system

The set of all connected equipment that provides an earth.

Contact voltage

The share of an earth voltage to which a person's body is exposed by contact with the installation. The current resulting from this voltage is limited by the resistance of the person's body and by the resistance of the ground on which he/she is located.

Step voltage

The share of an earth voltage to which a person is exposed by taking a step, in other words separating his/her feet by one metre. This voltage results in a current through the person's feet.

Earth voltage

Voltage measured between the earth and the reference earth.

Earth

The point of connection to the earth.

Reference earth

The part of the earth (notably its surface) outside the zone of influence of the earth contact or of the earthing system.

12. GLOSSARY

This glossary lists the terms and abbreviations used on the device and its digital display unit.

3 poles:	earth resistance measurement with 2 auxiliary electrodes (3P).
4 poles:	4-wire measurement of low earth resistance using 2 auxiliary electrodes (4P).
C_1:	coupling coefficient of earth R_A with earth R_b ($C_1 = R_C/R_1$).
C_2:	coupling coefficient of earth R_b with earth R_A ($C_2 = R_C/R_2$).
d, A:	distances to be programmed for the resistivity calculation depending on the measurement method used.
mΩ:	low resistance/continuity measurement.
E:	terminal E (earth electrode, measurement current return terminal)
EARTH:	earth measurement (3-pole or 4-pole).
EARTH COUPLING:	measurement of coupling between 2 earth electrodes.
ES:	terminal ES (acquisition of reference potential for the 4P earth resistance calculation).
H:	terminal H (measurement current injection terminal).
I-Act⁽¹⁾:	external current presently (Act) measured by the clamp (I_{ES}).
I_{ES}:	current measured by the clamp connected to terminal ES (selective earth measurement with clamp).
I_{H-E}:	measurement current flowing between terminals H and E.
NOISE:	indicates that a spurious external voltage is present and interfering with the earth or resistivity measurement.
R:	mean resistance calculated from R+ and R-.
R+:	resistance measured with a positive current flowing from terminal H to terminal E.
R-:	resistance measured with a negative current flowing from terminal H to terminal E.
R-Act⁽¹⁾:	present (Act) resistance calculated from values U-Act and I-Act.
R_1:	first value measured to calculate the coupling between 2 earth electrodes ($R_1 = R_A + R_C$).
R_2:	second value measured to calculate the coupling between 2 earth electrodes ($R_2 = R_b + R_C$).
R_{1-2}:	third value measured to calculate the coupling between 2 earth electrodes ($R_{1-2} = R_A + R_b$).
R_A:	first earth value calculated ($R_A = R_1 - R_C$).
R_b:	second earth value calculated ($R_b = R_2 - R_C$).
R_C:	coupling resistance between earths R_A and R_b ($R_C = (R_1 + R_2 - R_{1-2})/2$).
R_E:	resistance of the earth connected between terminal E and electrode S.
R_H:	resistance of the electrode connected to terminal H.
R_{LOOP}:	earth loop resistance (2 clamps).
R_{PASS}:	value of resistance R-Act (PASS for "passive" measurement made with the spurious current flowing in the installation).
R_S:	resistance of the electrode connected to terminal S.
R_{SEL}:	selective earth resistance (current measurement using clamp).
R_{S-ES}⁽²⁾:	resistance between electrodes S and ES (used for the resistivity measurement).
$R_{\Delta 0}$:	measurement leads compensation resistance.
S:	terminal S (acquisition of measurement potential for the earth resistance calculation).
U-Act⁽¹⁾:	present (Act) external voltage on the terminals of the device.
U_{H-E}:	voltage measured between terminals H and E.
U_{OUT}:	voltage generated by the device between its terminals H and E (32V or 16V).
U_{S-E}:	voltage measured between terminals S and E.
U_{S-ES}:	voltage measured between terminals S and ES.
USr:	frequency chosen by the user ("user" shortened).
ρ_S:	soil resistivity measured by the Schlumberger method.
ρ_W:	soil resistivity measured by the Wenner method.

(1): The suffix **Act** becomes **In** (for "Input") when this value is recorded in the device, then read, in order to distinguish between present value and recorded value. In both cases, the quantity displayed is associated with its frequency.

(2): In this case, the resistances of the 4 electrodes used for the measurement are indicated by R_{P-H} , R_{P-S} , R_{P-ES} , R_{P-E} .

13. MAINTENANCE

 For maintenance, use only the spare parts specified. The manufacturer cannot be held liable for any accident that occurs following a repair not performed by its customer service department or by an approved repairer.

13.1. CLEANING

Disconnect the unit completely and turn the rotary switch to OFF.

Use a soft cloth, dampened with soapy water. Rinse with a damp cloth and dry rapidly with a dry cloth or forced air. Do not use alcohol, solvents, or hydrocarbons.

13.2. REPLACEMENT OF THE FUSE

The device has two protection fuses with identical characteristics:

■ Fuse in terminal H:

If this fuse is defective, the instrument ceases to produce an output voltage and active resistance measurements are therefore impossible. To check the condition of the fuse, turn the switch to the 2-wire $m\Omega$ function, connect terminals H and E with a lead, and start a resistance measurement. If the instrument makes no measurement and if the symbol of terminal H flashes, the fuse must be replaced.

■ Fuse on clamp input ES:

If this fuse is defective, the instrument ceases to detect the presence of a clamp on input ES. Selective 4-pole earth measurements with clamp and two-clamp measurements become impossible.

To check the condition of the fuse, choose the 4-pole function and connect a clamp to terminal ES. If no clamp symbol appears alongside the symbol of terminal ES, the fuse must be replaced.

 To keep the device safe, replace the defective fuse only with a fuse having strictly identical characteristics:
 C.A reference of the batch of 10 F 0.63A – 250V – 5x20mm – 1.5kA fuses: AT0094

Replacement procedure:

1. Disconnect anything connected to the device, set the switch to OFF, and close the cover.
2. Unscrew the four captive screws of the bottom of the housing but do not withdraw them.
3. Open the cover of the housing; lift the instrument cautiously, supporting the front panel so that it does not fall. Delicately remove the front panel with the body of the device from the housing. The fuse of terminal H is now accessible and can be replaced.

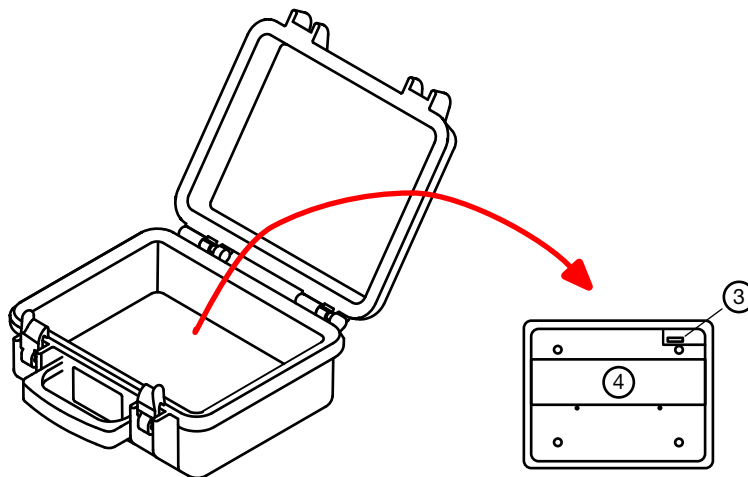

4. If only the fuse of terminal H needs to be replaced, go directly to point 9 below. If you also wish to replace the fuse of clamp input ES, unscrew both screws of the battery compartment cover and remove the cover.

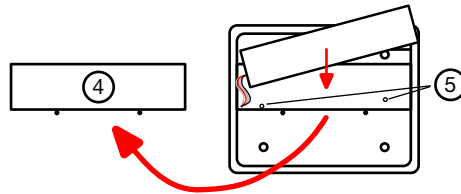

5. Slide the battery a short way out of its compartment, without forcing on the wires, in order to be able to loosen the two screws at the bottom of the battery compartment. Then put the battery back in its place.
6. Delicately lift the bottom of the device and withdraw it without forcing on the wires of the battery. Hold the battery to prevent its falling, then set the bottom down on the side to leave the fuse apparent. The fuse of the clamp input of terminal ES is now accessible on the printed circuit and can be replaced. Avoid touching the circuit and its components with your hands.

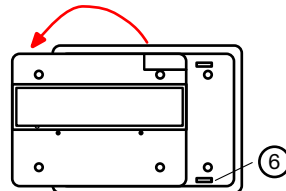

7. Put the bottom back in place on the front panel and put the electronics of the device back in place without forcing on the wires of the battery. Before lowering the bottom, align the four holes with the four attachment posts. Take care not to snag or crush any battery wire or other cable or component during this operation.
8. Slide the battery a short way out of its compartment, without forcing on the wires, and screw the two screws at the bottom of the compartment back in. Then put the battery back in its place.
9. Put the battery compartment cover back in place and tighten the screws.
10. Remove any dirt there might be on the seal and on the edge of the housing, using a lint-free soft cloth.

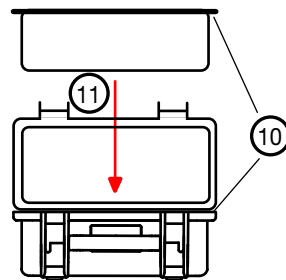

11. Place the body of the device in the housing, close the cover, and tighten the attachment screws.

13.3. REPLACING THE BATTERY

The battery of this device is specific: it has precisely matched protection and safety elements. Replacement of the battery by a model other than the one specified may result in damage to equipment or bodily injury by explosion or fire.

-  To keep the device safe, replace the battery only with the original model:
 C.A reference of the 9.6V, 3.5Ah rechargeable NiMH battery: P01.2960.21

Replacement procedure:

1. Disconnect anything connected to the device, set the switch to OFF, and close the cover.
2. Unscrew the four captive screws of the bottom of the housing but do not withdraw them.
3. Open the cover of the housing; lift the instrument cautiously, supporting the front panel so that it does not fall. Delicately remove the front panel with the body of the device from the housing.
4. Unscrew the two screws of the battery compartment cover and remove the cover.
5. Slide the battery a short way out of its compartment, without forcing on the wires, in order to be able to loosen the two screws at the bottom of the battery compartment. Then put the battery back in its place.
6. Delicately lift the bottom of the device and withdraw it without forcing on the wires of the battery. Hold the battery to prevent its falling, then set the bottom down on the side to leave the battery connector apparent.

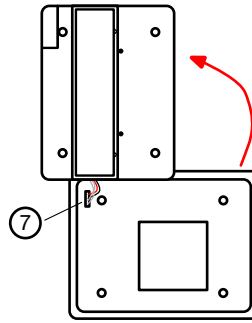

7. Disconnect the 4-point connector of the battery, pushing the tab slightly out of the way. Avoid touching the circuit and its components with your hands.
8. Remove the old battery from its compartment and install the new battery in its place. Pass the connecting wires and connector through the slot provided for this purpose.
9. Connect the battery connector with the two pins towards the clip. Avoid touching the circuit and its components with your hands.
10. Put the bottom back in place on the front panel and electronics of the device, without forcing on the wires of the battery. Before lowering the bottom, align the four holes with the four attachment posts. Take care not to snag or crush any battery wire or other cable or component during this operation.
11. Slide the battery a short way out of its compartment, without forcing on the wires, and screw the two screws at the bottom of the compartment back in. Then put the battery back in its place.
12. Put the battery compartment cover back in place and tighten the screws.
13. Remove any dirt there might be on the seal and on the edge of the housing, using a lint-free soft cloth.
14. Place the body of the device in the housing, close the cover, and tighten the attachment screws.
15. Fully charge the new battery before using the device.
16. Reprogram the date and time of the device (see §7.1).

13.4. METROLOGICAL CHECK

Like all measuring or testing devices, regular instrument verification is necessary.

This instrument should be checked at least once a year. For checks and calibrations, contact one of our accredited metrology laboratories (information and contact details available on request), at our Chauvin Arnoux subsidiary or the branch in your country.

13.5. REPAIR

For all repairs before or after expiry of warranty, please return the device to your distributor.

14. WARRANTY, SERVICE

Except as otherwise stated, our warranty is valid for **twelve months** starting from the date on which the equipment was sold. Extract from our General Conditions of Sale, communicated on request.

The warranty does not apply in the following cases:

- inappropriate use of the equipment or use with incompatible equipment;
- modifications made to the equipment without the explicit permission of the manufacturer's technical staff;
- work done on the device by a person not approved by the manufacturer;
- adaptation to a particular application not anticipated in the definition of the equipment or not indicated in the user manual;
- damage caused by shocks, falls, or floods.

15.2. REPLACEMENT PARTS

Batch of 10 F 0.63A, 250V, 5x20mm, 1.5kA fuses	AT0094
Adapter for charging of battery from line power	P01102035
18V/1.5A AC/DC adapter + 2-pole line power cord.	
Rechargeable battery: 9.6V, 3.5Ah NiMH storage battery	P01296021
Optical/USB communication cable	HX0056-Z
Prestige carrying bag	P01298067

Miscellaneous

- Replacement parts for Earth & resistivity kit: see the list enclosed with the standard kit or contact your Chauvin Arnoux agency or your approved dealer.