

Paper • Cardboard moisture meter

KG - 1 0 1

- Electric moisture meter -

Operating Instruction MANUALS

CAUTIONS:

- Before using the Meter, read this INSTRUCTION MANUAL thoroughly and use the Meter correctly.
- Keep this INSTRUCTION MANUAL with care and refer to it when necessary.
- In the event of any discrepancies, the original INSTRUCTION MANUAL in Japanese is to be of final authority.

Thank you for your purchase of this Paper• Cardboard Moisture Meter KG-101.

SANKO ELECTRONIC LABORATORY is a leading company in Japan in a comprehensive range of Electronic inspection meters like Coating Thickness Meters, Moisture Meters, Pinhole Detectors, Iron piece Detectors, etc.

We try the utmost effort to satisfy user's needs in development, manufacture and supply of the instruments, and to achieve the worldwide service and support network of this meter.

For more information visit our website at <http://www.sanko-denshi.co.jp>.

Your Paper• Cardboard Moisture Meter KG-101 is packed in cardboard and plastic packaging.

Please ensure that this packaging is disposed of in an environmentally sensitive manner, which may be instructed by your Local Environmental Authority.

To maximize the benefits of your new Paper• Cardboard Moisture Meter KG-101 please take some time to read these operating instructions.

Contents

1. Characteristics • Applications	2
2. Specifications	2
3. Names	3
3-1. Main body	3
3-2. Probe	4
4. How to use	5
4-1. Connection or disconnection of probes	5
4-2. Power ON•OFF	5
4-3. Changes of measuring mode	5
4-4. Changes of hold mode	6
4-5. Setting of upper limit values	7
4-6. Changes of key lock mode	7
5. Measurements	8
5-1. Real time measurement	8
5-2. Measurement of average value indication (temporary memory)	9
6. Measurement of MC mode	10
7. About temperature compensating	10
8. Remarks on measurements	10
9. Dry batteries	11
10. Maintenance • Preservation	11
11. Others	12
11 -1. How to use Moisture reading checker	12
11-2. Replacement of needle electrodes	12

1. Characteristics • Applications

- Capable of measuring moisture contents of papers, paper products, paper parts, etc. by pressing (needle electrode : stabbing) a probe to measuring objects.
- MC(Moisture content) mode makes it possible to measure all kinds of objects.
Switching of the mode of a body is capable of comparing and classifying states of dryness • wetness of measuring objects with a displayed numerical value of 1 to 100(without unit) which leads to quick and easy checking

Paper • Cardboard (K)	For moisture control while storing the High quality paper, Craft, sheet, or secondhand-used papers. Cardboard, Envelopes, Paper articles, Decorated papers, etc. and other paper products and half-finished paper products.
Moisture Content (MC-5)	Judging measurement results by comparing displayed numerical values of moisture contents of textiles, Foods, Chemical synthesis, Ceramic, etc. which once considered difficult to measure.

2. Specifications

Model	AQUA SEARCH SERIES KG-101
Method	DC electric resistance type Mass moisture%
Range	6.0 to 40.0% 1 to 100(MC mode)
Resolution	0.1% , 1(MC mode)
Accuracy	± 3% (read-out value)
Mode	Paper • Cardboard , Moisture content comparison
Average Value Display	Max. 20 points of average value data (Switch off to delete)
Display	LCD indication with HOLD function In addition to a measuring value, measuring mode, HOLD, TEMP, Upper limit value setting and Battery residue are displayed
Upper limit value setting	Setting of optional numerical value of upper limit 6.5 to 39.5% (0.5% step), MC : 2 to 99 (1 step)
Probe	Small stabbing (Inserting) 2 needle electrode + Small sized SB electrode
Temperature compensating	Automatic temperature compensating function (ON-OFF function available)
Power	Alkali dry battery LR03 (1.5V) × 4, Non-stop running 100 hrs (approx.) Auto-power OFF
Operating temperature	0 to 40 (Non-condensing)
Dimensions & Weight	80(W) × 35(H) × 150(D) mm, 370g
Accessories	Carrying case, Spare needles, Hexagon wrench (2 mm)
Option	Conducting rubber electrode, Roller electrode, Moisture reading checker

*** Specifications and appearances subject to change due to improvement without prior notice.**

3. Names

3-1 Main body

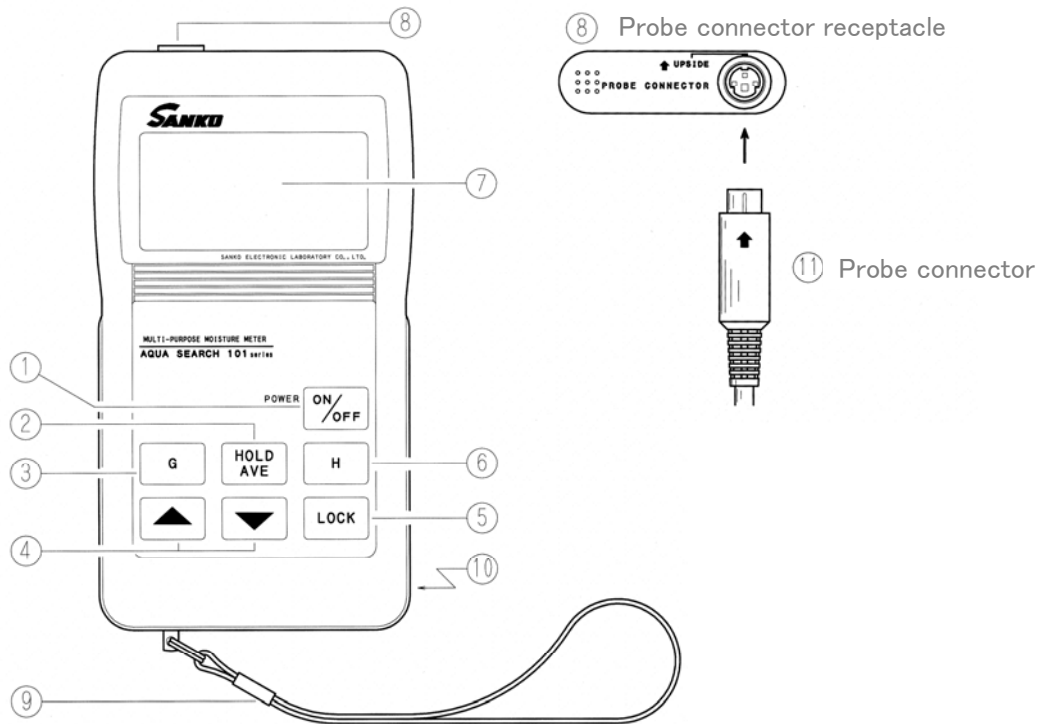

① Power SW (POWER)

Switch ON or OFF. Switch ON after a probe has been hooked up to a main body.

A display turns automatically to Error [E01] and Power-OFF because of Self Analysis Function when any abnormality is detected in the inner circuitry of a body.

② Hold Average Key (HOLD/AVE)

It changes ON or OFF alternately whenever pushed.

A press of long periods (approx. 1 sec.) measures Average Statistical Mode (Max. measuring point 20).

An average value can automatically be displayed after 20 points have been measured.

Repress the key to stop the measurement for getting an average value at less than 20 points.

A press of long periods (approx. 2 sec.) releases the mode and turn to a normal measurement.

And POWER OFF also releases the mode.

③ Mode Change Key (G)

Each press of the key switches Mode in turn to Paper • Cardboard (K) or MC-5 (Moisture content) mode for each moisture measurement.

④ Numerical value setting key (▲, ▼)

This is a key to set to an upper limit value.

The 「▲」, 「▼」 key moves up and down by a 0.5% notch (a 1 notch for MC mode) and keep the key pressed for a fast forward winding (rewinding).

The 「▼」 Key makes it possible to delete a point only of a latest measuring value at Average Statistical Mode in a measuring process.

Switch the Automatic temperature compensating function to ON or OFF. Refer for details to 「7. About temperature compensating」.

⑤ Lock key (LOCK)

A press of a Lock key locks all the keys except POWER SW which prevents erroneous operations.
 Switch OFF to release the lock.

⑥ Upper Limit Value Key (H)

Switch on Upper Limit Value Mode.

Set to an optional numerical value with a numerical value setting key .

⑦ LCD Display

Measuring Modes, measuring values, upper limit setting, temperature compensating, battery residue, etc.
 are to be indicated on the LCD.

⑧ Probe connector receptacle

This is a connector to be hooked up to a probe.

⑨ Hand strap

To protect this instrument from dropping, make sure that the hand strap be hung through over an operator's
 wrist.

⑩ Battery Case (back Lower part of a main body)

Batteries are to be placed.

3-2 Probe

Small-sized-2-needles Probe with SB Electrode

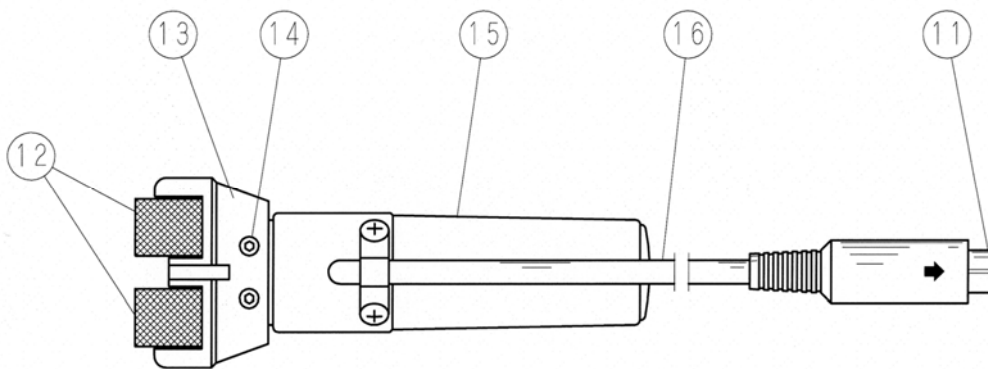

⑪ Probe Connector

⑫ SB brass mesh electrode

⑬ SB electrode block (small sized 2 needles electrode when remove)

⑭ Hexagon socket set screw for the electrode block

⑮ Handle

⑯ Probe Cord

4. How to use

4-1 Connection or disconnection of probe

(ensure that Power Source of a main body is OFF).

- Hook up the Probe connector to a main body to meet the Arrow Mark of the Probe Connector with the Mark of Probe Connector Receptacle and insert it carefully up to the end of a stroke.
- Switch Power OFF to disconnect Probe Connector from the receptacle.

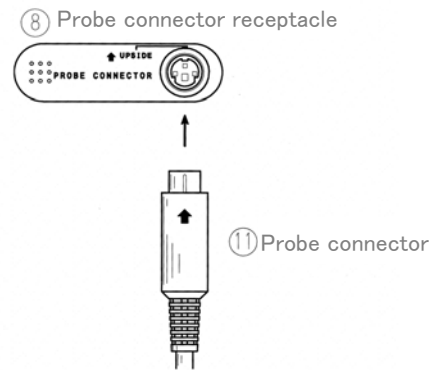

* Unnatural force in inserting and pulling off may cause damages to connectors in a receptacle and a cord.

4-2 POWER ON•OFF

- Press Power SW to emit a “Peep” sound ,and “LLL” and Measuring Mode “ K” marks are displayed .
- Press again to switch OFF, emitting a “Peep” sound to turn off the display.
- Availability of Auto-Power-OFF preventing batteries from being consumed when Power is forgotten to switch off. An interval of 3 minutes without operation of measuring will automatically switch off.

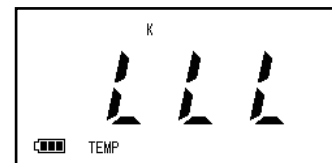

* Press Power SW to ON or OFF at an interval of 3 to 5 seconds to prevent operating errors.

4-3 Changes of Measuring Mode

- When Power is ON, 「 K 」 Paper • Cardboard Mode is displayed.
- For changes of Measuring Mode, press a Mode-Change 「 G 」 key to change the following turns by each press.

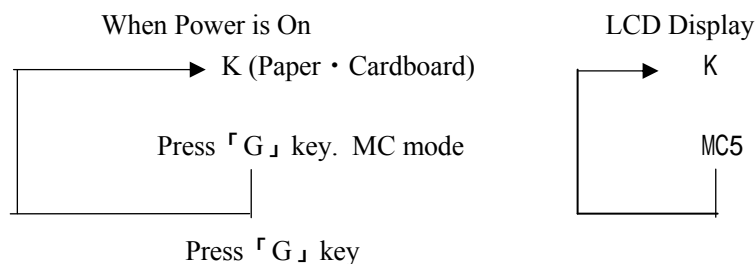

- Returning again to ON from OFF, the mode automatically returns to an initial measuring modes. Confirm a measuring mode when Power is ON.
- 「TEMP」 is not displayed with the MC mode of Moisture Content because there is no temperature compensating with the mode.

4-4 Changes of Hold Mode

A press of Hold Average Key turns to the Hold Mode with a 「peep」 sound. Each press of the key changes the Hold Mode alternately to ON or OFF and 「Hold」 is displayed on LC Display when ON is in process. The displayed measuring value is on hold until a next measuring value has been input.

- * A press of long periods (approx. 1 sec.) turns to Average Value Mode (temporary memory). To release it, press again and hold the Hold
- Average Key for long periods (approx. 2 sec.).

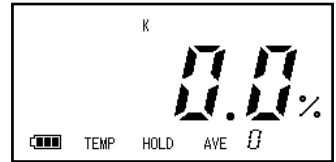
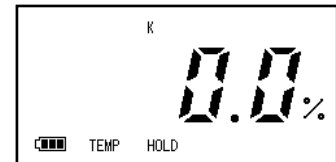

4-5. Setting of Upper Limit Values

- Press the Upper Limit Key 「H」 when Power ON is in process.
- A buzzer emits 「peep」 sounds and the 「H」, 「」 marks of an upper limit value indications and 「40.0%」 of the range of the upper limit are displayed.
- Press and hold a 「」 key until it has reached to a desired upper limit value. Keeping the 「」 key pressed changes to a fast winding of numerical values.
- Release your finger of the 「」 key when the values has reached to a desired value.
- When the value has reached too small beyond the desired one, press the 「」 Key to adjust the value .
- Set an upper limit value by pressing the 「H」 key again.
- A buzzer emits a “Peep” sound and the upper limit setting mark 「」 is indicated on the edge of the left side of LCD display .

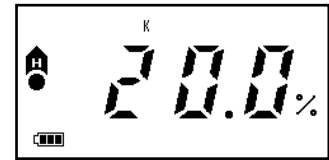

ex) set upper limit value to 20%

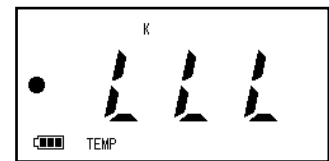

- * An interval between setting values is a 0.5% notch.
- * “TEMP”, “HOLD” is not displayed during in process of setting.
- * Possible to activate the same operations even at the MC mode.
- At a real time measuring, it sounds a buzzer “Peep, Peep, Peep” when a measuring value exceeds a setting value, and the upper limit value and the measuring value alternately blinks on the display while being probed to contact. Releasing the probe turns to 「LLL」 on display.
- At a Hold Mode measuring, when it exceeds the setting value and even after releasing the probe off the object, the upper limit value and the measured value are alternately kept blinking.

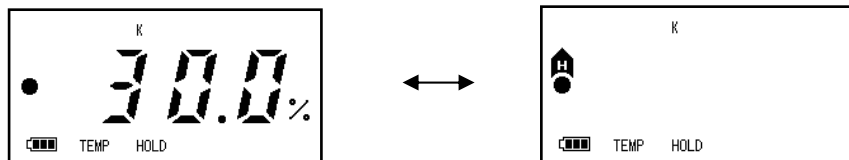

- Press a 「H」 key again and repeat the same procedures as before to change upper limit values. Possible to operate the same procedures during measuring in process (Hold mode or Non-Hold mode).

- * When Upper Limit Value is unnecessary for an initial operation, press again the 「H」 key after pressing first the 「H」 key. In this case the Upper Limit Value is set at 40%, Maximum.
- * To delete an Upper Limit Value, set the Upper Limit Value at 40 % or switch Power to OFF. And the Upper Limit Value will also be deleted when Power switches OFF with Auto-Power-Off.

4-6 Changes of Key -Lock Mode

A press of a Lock Key locks all the keys except Power SW and prevents erroneous operations. Switch off Power to release.

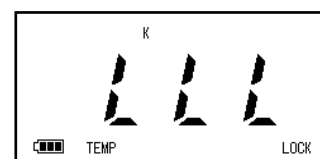

5. Measurements

5-1 Real time measurement

1. Turn on Power SW and confirm an indication of LCD.

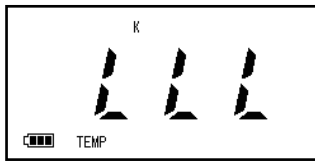

Display of measuring mode of 「K」Paper • Cardboard and 「LLL」

- Turning on Power while inserting the probe to the object indicates 「LLL」 once on the display and then displays a measuring value in 2 to 3 seconds.
2. Select a mode suitable for the measuring object by pressing a Mode Change key 「G」 .
(refer to 4-3 changes of measuring modes on page 5)
 3. Wait for reading the display until the display has become stable by inserting Electrode into the measuring object (note 1, 2).
 4. Press a Hold Average key to display 「0.0 %」 with a sound of “Peep”.

When probing an object, it emits “peep, peep” sounds and when releasing it, a “peep” sound again with a measured valued indicated on LCD .

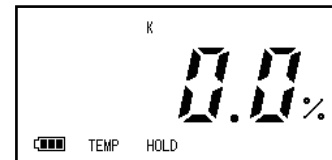

- * **Do not probe other object until the above sounds of 3 times has finished otherwise that may cause measurement errors.**

An indicated value does not change when a measured value indicates not more than the measurement range.

When a measured value indicates not less than the measurement range, 「HHH」 blinks with sounds of “ peep, peep, peep”.

Releasing a probe displays 「0.0%」 .

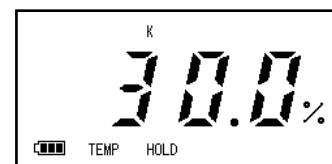

5. Press a Hold • Average key again for releasing the Hold state.

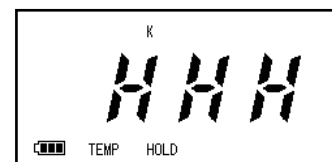

Note 1) Measuring with SB Electrode:

A SB Electrode is composed of a brass net and a resin core(elastic) to make them fit properly to paper objects and keeps a stable press on the objects flexibly even on an uneven face.

Note 2) Measuring with 2-Needles Electrode:

In case of measuring by stabbing the needle electrode into a measurement object, make sure that Hold Mode is kept released until the stabbing process finished, and then that the Hold Average key is pressed to switch to the Hold mode when the measurement value is read after the stabbing process finished.

(Stabbing-measurements with Hold mode in process may cause measurement errors because data in process of stabbing is held and displayed.)

5-2 Measurement of Average Value Indication (Temporary Memory)

1. A long press (approx. 1 sec.) of a Hold • Average Key performs temporary Memory Measurement to display Average Value Indications.

(A max. measurement point capable for Temporary Memory is 20)

2. This Temporary Memory can be deleted when Power is OFF

(and Auto-Power OFF is as well)

3. Average Value Measurement is performed in a measurement of Hold Mode.

Measured data memory is capable of memorizing temporarily 「 AVE 1 」 , 「 AVE 2 」 , and 「 AVE 20 」 at the Maximum.

4. A press of the Hold • Average key during in process of the measurement turns to Average Value mode and on LCD 「 AVE__ 」 is indicated and shows the average value measured up to the points.

Then by operating numerical value setting keys 「 」 , 「 」 , measured values can be recalled and confirmed.

On the place of [AVE] on display, recalled measured numbers (1 to 20) are indicated and each measured value can also be confirmed respectively.

And then [HOLD] or [AVE] is not indicated.

* During this mode, Auto Power OFF can not be operated.

* An Average Value Mode can not return to a measuring operation.

When returning, refer again to 7. below and try to set again.

5. When reading erroneous data during a measurement of Average Value Indications, a long press and hold (1 sec.) of a Numerical Value Setting Key 「 」 is capable of deleting the only last data stored (* Only possible to operate the latest measured data.)

6. When measured numbers has reached 20 items, it automatically turns to Average Value Indication mode in a second (the data at the 20th can not be deleted by operating any keys)

Release the mode to return to a measuring operation.

7. A long press and hold (approx. 2 sec.) of the Hold • Average key make it possible to release the mode.

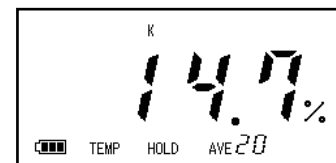
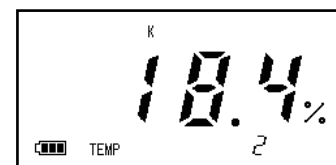
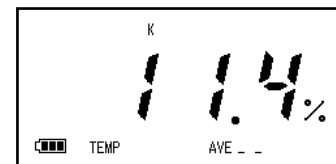
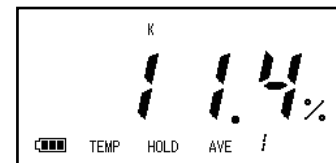
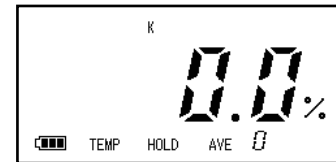

1 second after

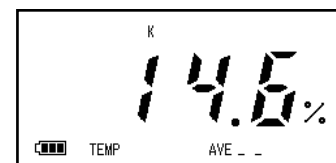

- Power SW key and Hold • Average key can only be used during a measurement in process of Average Value Indication.
- During a measurement of Average Value Indication, a setting function of Upper Limit Values turns ineffective. When actuating Average Value Indication measurement during a use of a setting function of Upper Limit Value, the setting function of an Upper Limit Value turn ineffective.
But, even in this case Upper Limit Value is being in process of storing unless Power is switched OFF, and it returns to the Upper Value setting when a measurement of Average Value Indications has finished.

6. Measurement of Moisture Content (MC) mode

Select Moisture Content Mode by pressing a Mode Change key after turning Power to ON.

This MC mode is capable of using broad objects relating to Resistance.

Changes of electric resistance depending on dryness and moisture indicates numerical values

「1 to 100」 (No Unit) . Checking relatively comparative values makes it easy to classify and compare objects.

This MC measurement mode as well as when measuring Moisture can use all the functions although each of them does not display [%] .

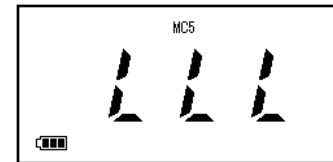

7. About Temperature Compensating

- Automatic Temperature Compensating Function is set to ON at the initial setting of this meter and the LCD indicates [TEMP] .

(There is no Temperature Compensating with the MC mode measurement.)

- Auto Temperature Compensation function is performed at a basis of an indicated value of 20 .
- Turn Auto Temperature Compensation function to OFF for measurements when measuring objects are heated up because of a baking (dry) heat treatment.
- Differences of temperatures between a main body and a probe cause measurement errors.
- Press 「 」 and 「 」 of Numerical Value setting keys at the same time to change Auto Temperature Compensation to ON or OFF.

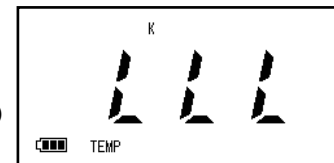

And then that make it possible to understand the changes whether [TEMP] is indicated or not on the LCD , depending on the key operations.

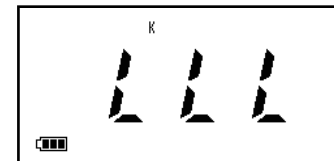

Refer to a table below for temperature compensation when Automatic Temperature Compensation function is OFF.

Measuring temperature	Compensating value to Instructed read
Over 20	- 0.1 % per 1
Below 20	+0.1 % per 1

8. Remarks on measurements

Measuring values may disperse according to measuring circumstances.

Electric Resistor Type Moisture meters use the applications of sensitively electric characteristics of measuring objects against the moisture contents and the corresponding relations never be a perfectly correlative one- to- one.

In case of measuring with different compositions • combinations, albeit the same material , or with changes in quality, contamination, and furthermore with special processing, chemical treatments, it may be necessary to avert measuring such unfavorable objects, and compensate or average measured values. As for compensating, it is, in general, based on moisture measurement methods in accordance with a drying process.

9. Dry batteries

9-1 Indication of Voltage-drop

Batteries run short when a battery mark indicating the state of charge of the batteries turns to 1 on the left lower side of LCD . By sliding open the lid of the battery case placed on the backside of a main body, replace all the old batteries with new ones (watch battery life). Alkali dry battery (LR03) × 4

In case batteries are kept used with a one of the 3-battery-indication sections (least remained), the mark turns to a battery frame only (short of the battery) and in Approx. 5 seconds Power will switch OFF, ceasing further uses.

Battery residue indication

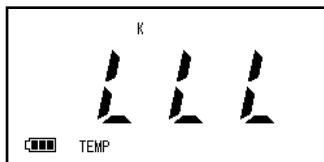

fully remained

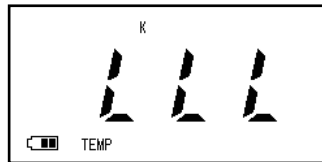

less remained

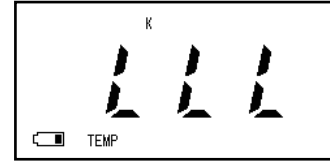

least remained

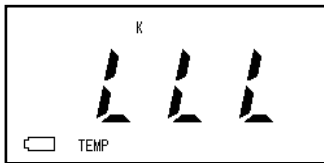

Power will switch off in 5 seconds.
 Replace them with new ones.

9-2 Batteries while not in use.

- Batteries drain a minimum even while not in use.
- In case of keeping a meter unused for more than a month, remove the batteries from the case for storing.

10. Maintenance • Preservation

- * Clean and wipe off dirt with soft clothes. Pay attention to connector part, electrodes and grooves of electrodes of a probe and keep them clean and dry.
 - * Prevent a meter from impulse, direct sunlight, and high humidity.
 - * Choose a clean and dry place for preservation.
- Remove batteries from the case for a long-term preservation.

11. Others

11-1 How to use moisture reading checker (option)

Touch the electrode to the checker illustrated below when Power is ON.

It is a good condition if indicated values are as per listed on the checker.

If indicated values deviate, contact a store or our sales office to get it corrected. (subject to pay)

- * Turn a Temperature Compensating Function to OFF to use the checker.
Refer to 「 7 About Temperature compensating 」 at page 10 in details.
- * Moisture Reading Checker has 2 different checking points in a front side and a back side.
Use the checker with confirmation of the object to be checked and a measuring mode without fail.

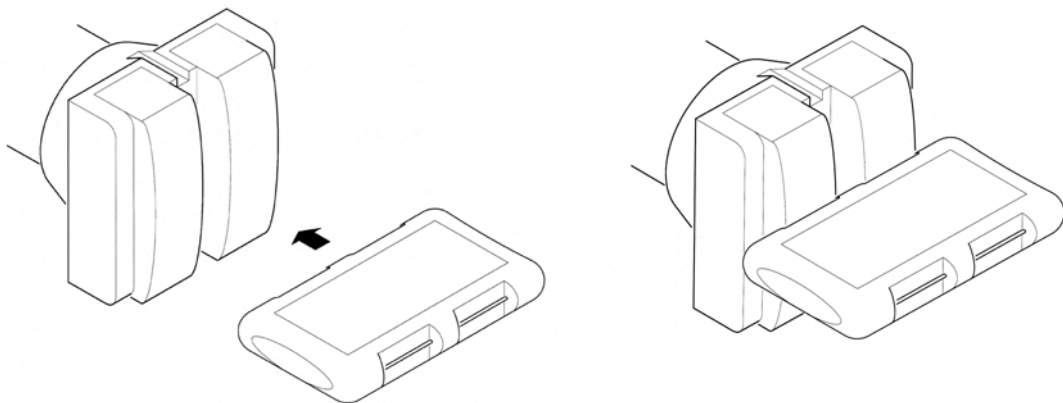

11-2 Replacement of Needle electrode

Take off a SB brass mesh electrode and a Needle Electrode Probe appears.

The needle electrode can be replaced loosing a Hexagon socket set screw for needle fixing with a furnished accessory Hexagon wrench.

Make sure that the hexagon socket set screw is set and screwed to strike a notch face of the needle electrode, otherwise it may cause the electrode to loose and drop off the body.

Hexagon socket set screw for needle fixing

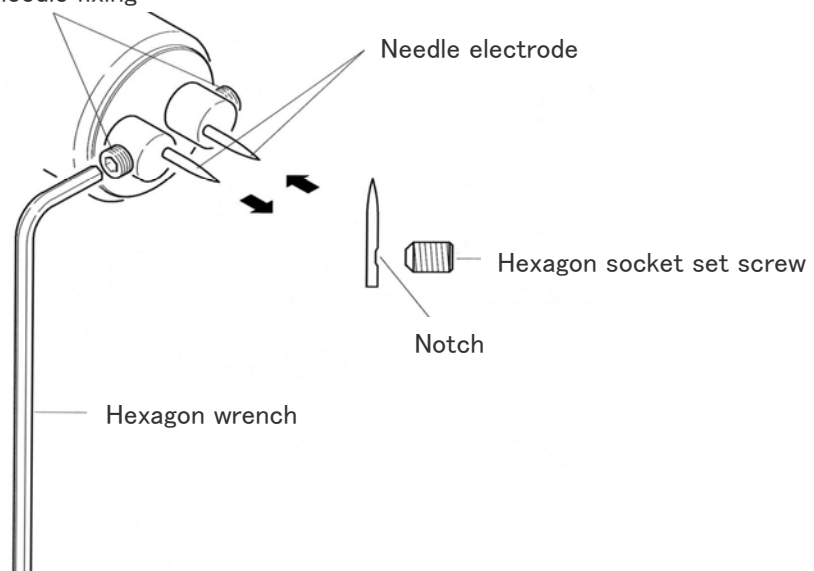

Storage:

This moisture meter incorporates a Liquid Crystal Display (LCD).

If the display is heated above 50 (120°F) it may be damaged.

This can happen if the moisture meter is left in a car parked in strong sunlight.